

## 2.4, 5, and 6 GHz Chip Antenna, BT / Wi-Fi 6E, Tri-band, Single-feed, Corner Mount, AEC-Q200 Qualified

Johanson Technology, Inc. (JTI) miniature RF ceramic chip antennas are made using Low Temperature Co-fired Ceramic (LTCC) technology which has the ability to embed low and high dielectric constants inside our antenna. This enables our components to have high detuning resilience and stability over extreme temperatures (~2ppm).

Recommended mounting locations for this antenna

PCB Corner

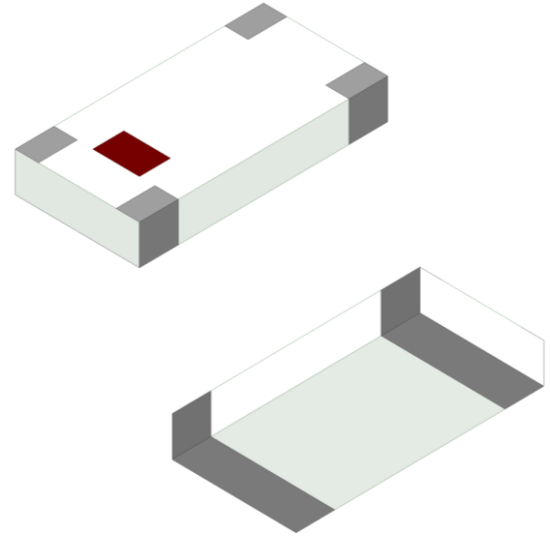

### General Specifications<sup>1 2</sup>

Passband Frequency (MHz)	2400 - 2500	4900 - 5850	5850 - 7200
Impedance ( $\Omega$ )	50	50	50
Return Loss (dB)	6 Typ. (4.4 Min.)	5 Typ. (4.4 Min.)	5 Typ. (4.4 Min.)
Peak Gain (dBi)	1.9 Typ.	1.1 Typ.	3.0 Typ.
Average Gain (dBi)	-1.2 Typ.	-2.0 Typ.	-1.1 Typ.
Average Radiated Efficiency (%)	67	72	80

### Maximum Ratings

Power Capacity (W)	1 Max. (CW)
Operating Temperature ( $^{\circ}\text{C}$ )	-40 to +105
Recommended Storage Conditions post-installation ( $^{\circ}\text{C}$ )	-40 to +105
Recommended Storage Conditions and Period for Unused T&R Product	45% - 75% RH +5 to +35 $^{\circ}\text{C}$ 18 Months Max.

<sup>1</sup> Typical value represents average measurement at 25 $^{\circ}\text{C}$ . Min./Max. values represent measurements over specified operating temperature.

<sup>2</sup> General specifications measured on Johanson's evaluation board P/N 2450AD18A6050001CE1.

**Mechanical Dimensions**

	Inches			Millimeters		
<b>L</b>	0.126	±	0.008	3.20	±	0.20
<b>W</b>	0.063	±	0.008	1.60	±	0.20
<b>T</b>	0.020	±	0.004	0.50	±	0.10
<b>a</b>	0.012	+0.004/-0.008		0.30	+0.10/-0.20	
<b>b</b>	0.020	±	0.004	0.50	±	0.10

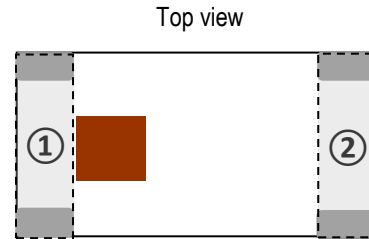
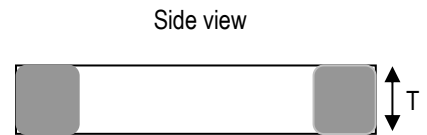
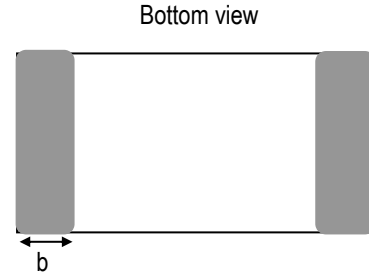
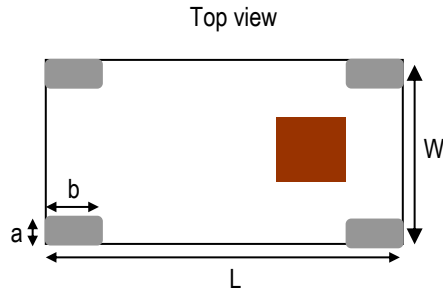

**Terminal Configuration<sup>3</sup>**

Pin Number	Function
1	Feed
2	NC*

<sup>3</sup> The termination type is Nickel Tin. Go to: <https://www.johansontechnology.com/ipcsoldering-profile> for Typical Soldering Profile.

\* This terminal must be soldered for anchoring and mechanical stability.

**Evaluation Board and Recommended Mounting Configuration (P/N 2450AD18A6050001CE1)**

All units in mm

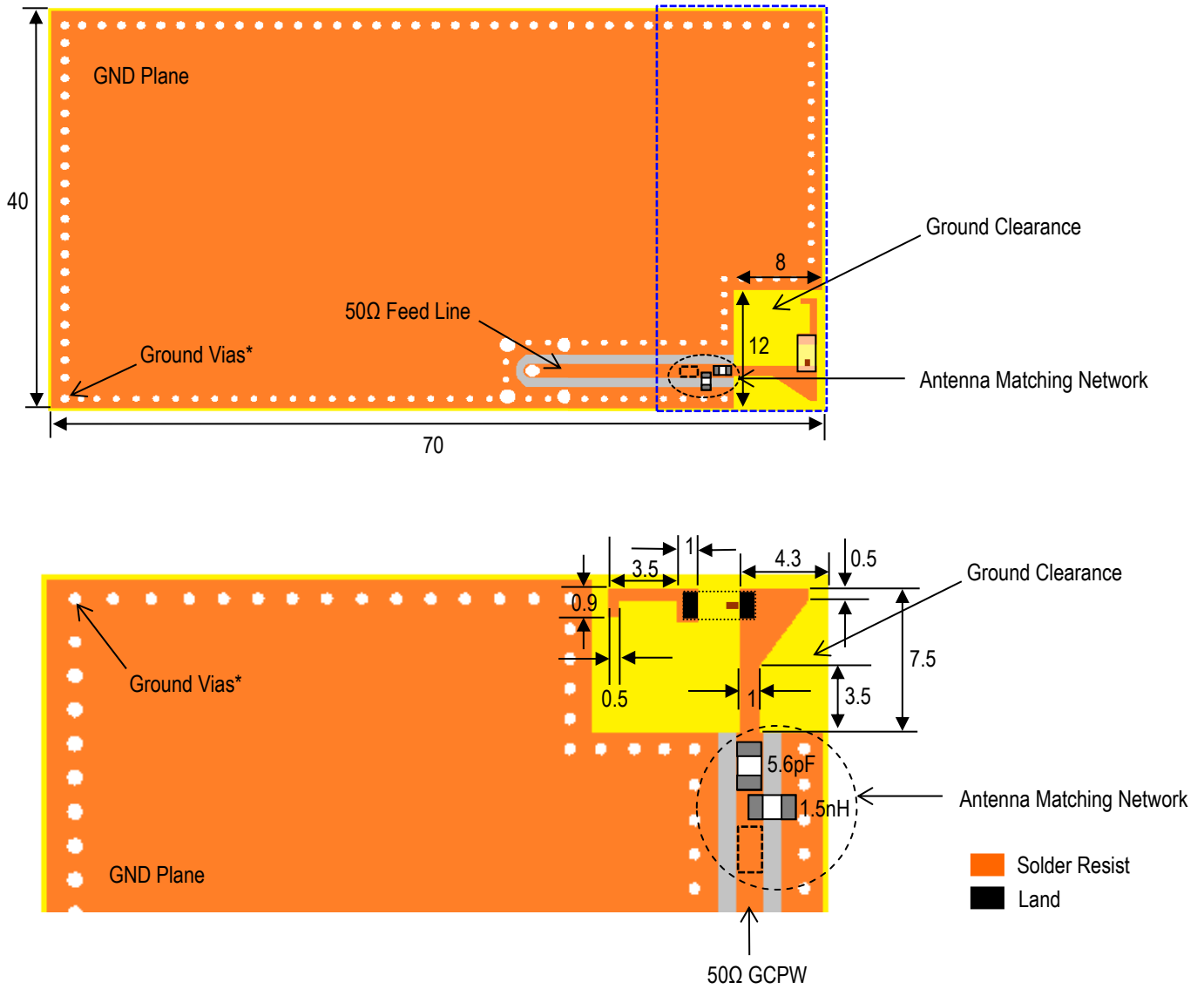

JTI P/Ns for Matching Network<sup>4</sup>

Capacitor (5.6pF): QSCF500Q5R6B1GV001T

Inductor (1.5nH): LRC0402CS1N5GV001T

\*Note: Ground Vias are highly recommended to have better antenna efficiency.

If you'd like the CAD PCB layout or have any questions,  
contact our application engineers at <https://www.johansontechnology.com/ask-a-question>

<sup>4</sup> It is recommended that the designer leave available slots for a "T" (or series-shunt-series) network. The antenna matching network values above are used when the antenna is mounted on Johanson's evaluation board. The optimal matching values will vary depending on the layout, thickness, material, etc. Go to: <https://www.johansontechnology.com/tuning> for more information.

**Evaluation Board Typical Return Loss Measurement (P/N 2450AD18A6050001CE1)**

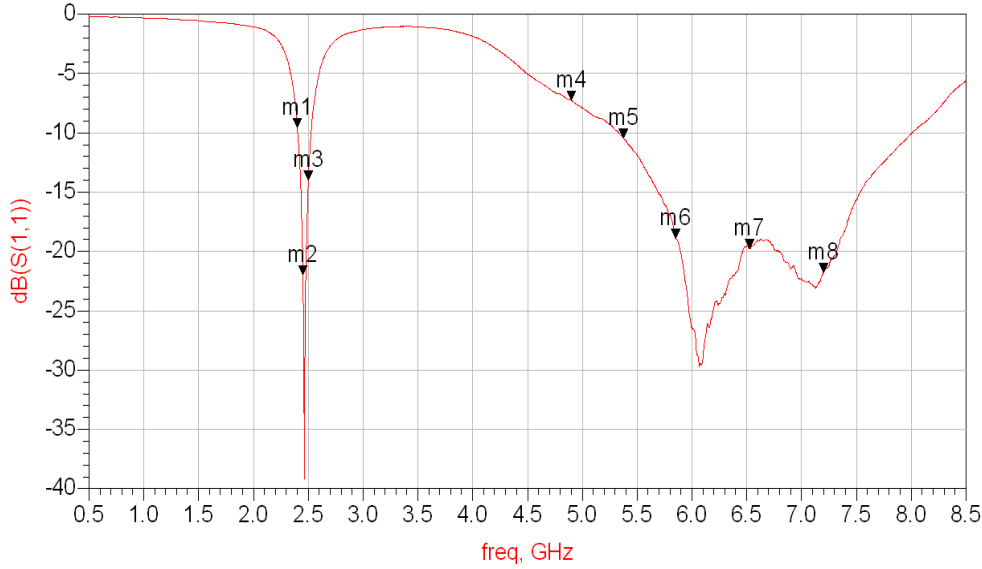

m1 freq=2.400GHz dB(S(1,1))=-9.555	m5 freq=5.375GHz dB(S(1,1))=-10.416
m2 freq=2.450GHz dB(S(1,1))=-21.986	m6 freq=5.850GHz dB(S(1,1))=-18.867
m3 freq=2.500GHz dB(S(1,1))=-13.981	m7 freq=6.525GHz dB(S(1,1))=-19.755
	m8 freq=7.200GHz dB(S(1,1))=-21.746

**Evaluation Board Typical 2D Radiation Patterns (P/N 2450AD18A6050001CE1)**

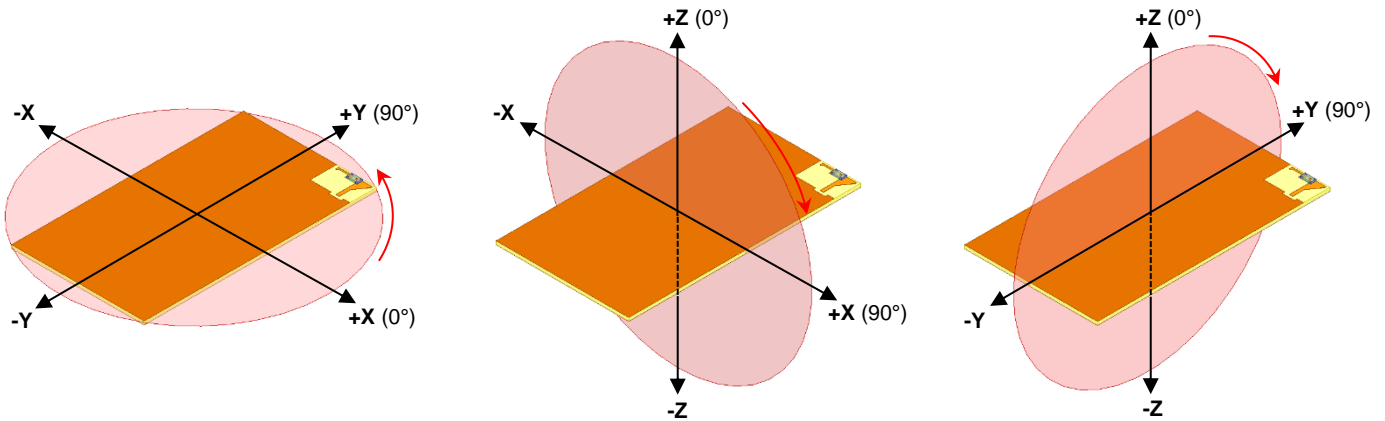

**@2.45GHz Band**

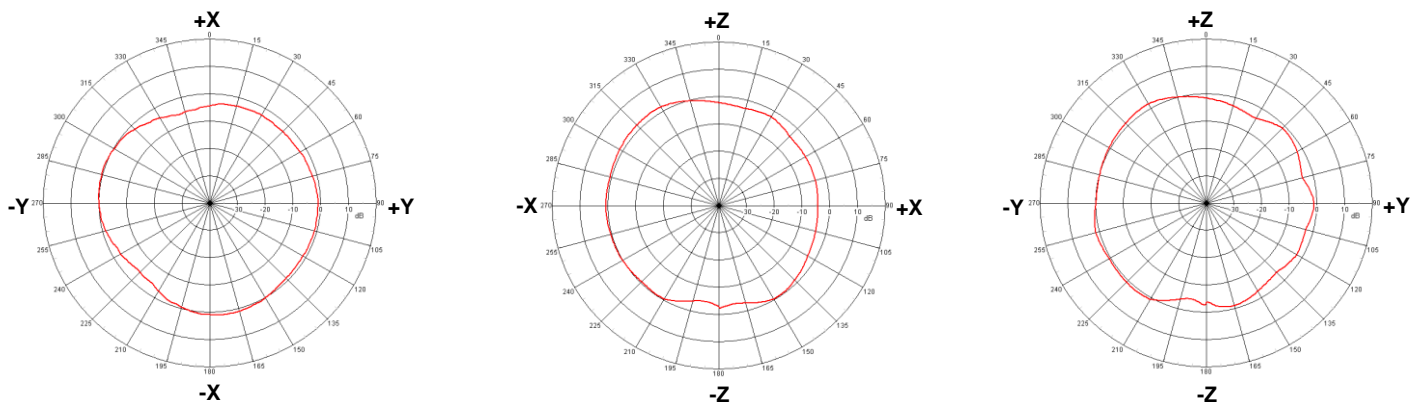

**@5.375GHz Band**

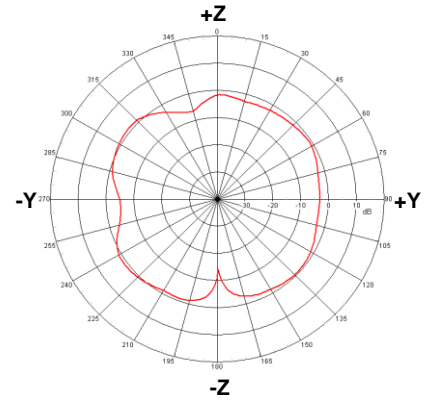
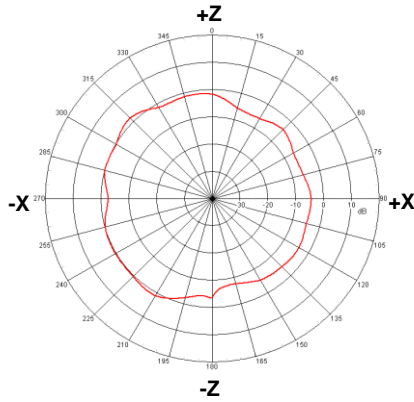
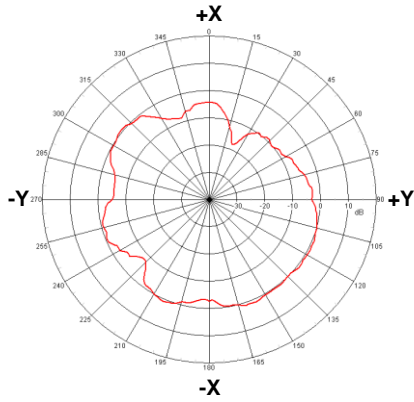

**@6.525GHz Band**

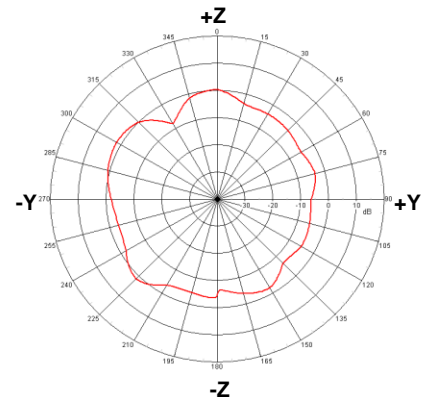
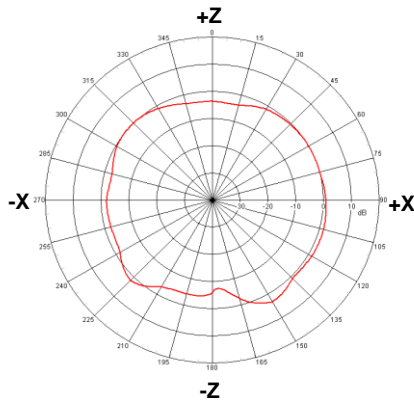
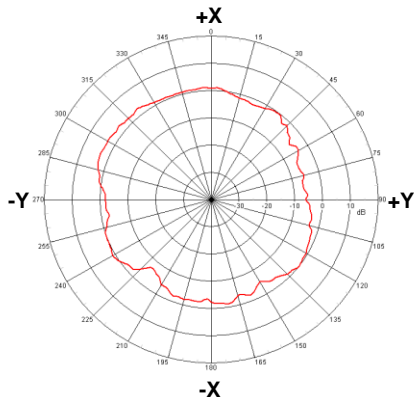

**Tape and Reel Specification (Units in mm)**

**Tape Dimensions**

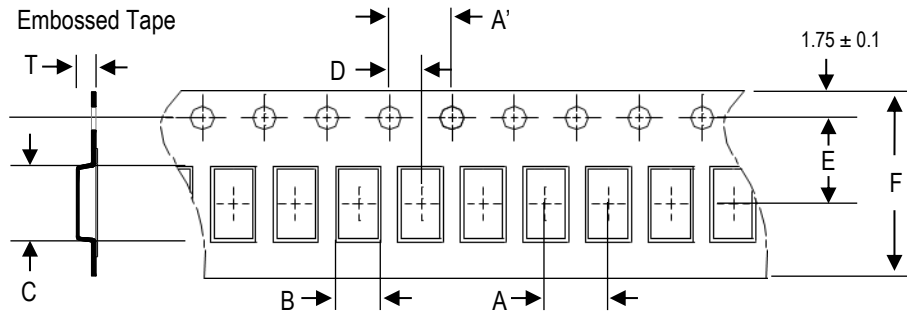

A	A'	B	C	D	E	F	T	Quantity/reel	Tape material
4.0±0.1	4.0±0.1	1.85±0.1	3.5±0.1	2.0±0.05	3.5±0.1	8.0±0.1	0.57±0.01	3,000pcs.	Plastic (Embossed)

**Reel Dimensions**

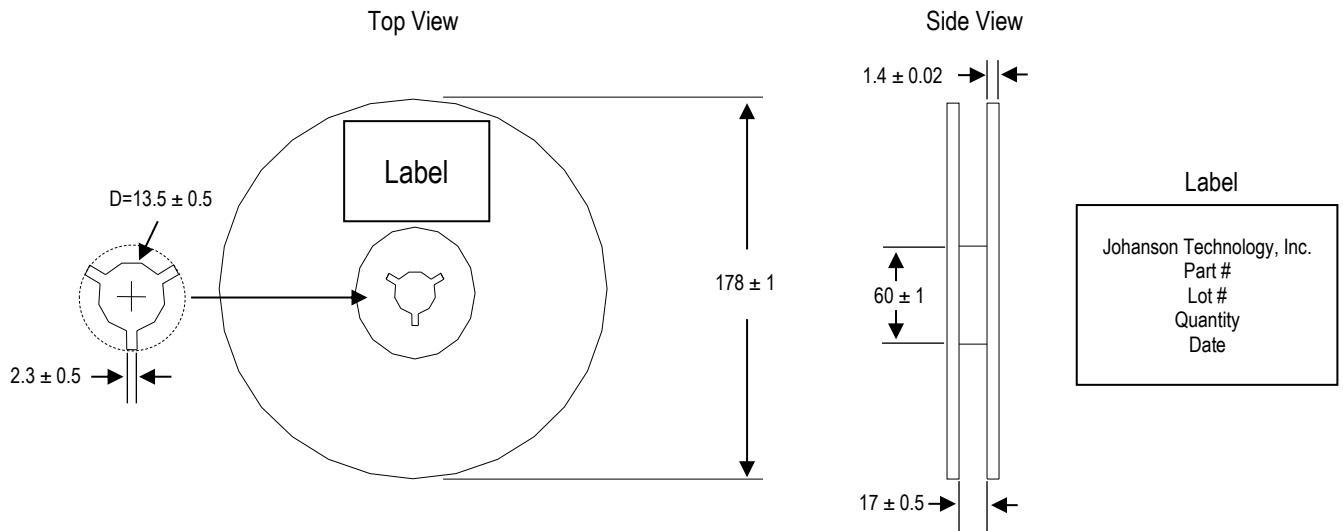

**Leader and Trailer Dimensions**

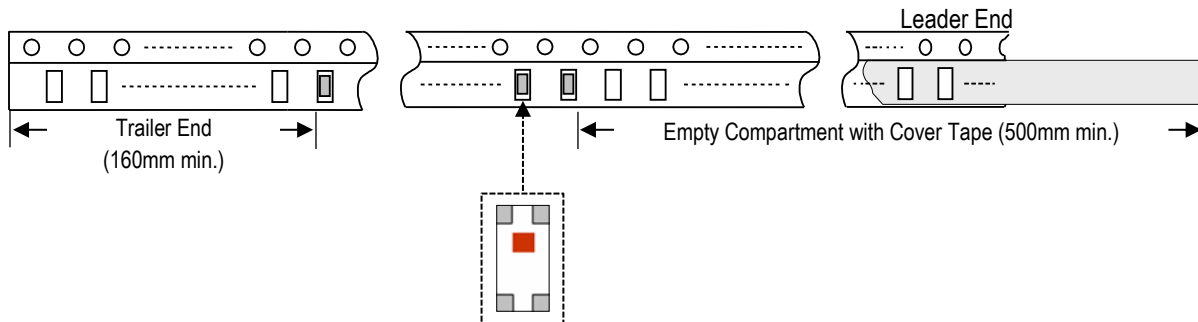

**Orderable Part Number**

Packaging Style	Part Number	Termination
Bulk (loose pcs.)	2450AD18A6050002B	Nickel Tin
T & R (7" Reel Embossed Tape)	2450AD18A6050002E (Qty: 3,000 pcs./reel)	
Evaluation Board with 1 SMA Connector	2450AD18A6050001CE1	

**Important Links**

[2450AD18A6050002E Product Page](#)

[More Chip Antennas](#)

[Antenna Tuning, Optimization, and Validation Services](#)

[Soldering Information](#)

[MSL Information](#)

[Packaging Information](#)

[Recommended Storage Condition and Max Shelf Life](#)

[RoHS Compliance](#)

*Contact our application engineers for a PCB layout review.*

**Johanson Technology, Inc. reserves the right to make design changes without notice.**

**All sales are subject to Johanson Technology, Inc. terms and conditions.**