

2.44 GHz RF Chip Antenna

- 2.4 – 2.48 GHz pass band
- Bluetooth, WLAN
- Ultra-Miniature SMD, EIA 0402
- Mid-edge mount
- RoHS compliant and AEC-Q200 Qualified

Johanson Technology, Inc. (JTI) miniature RF ceramic chip antennas are made using Low Temperature Co-fired Ceramic (LTCC) technology which has the ability to embed low and high dielectric constants inside our antenna. This enables our components to have high detuning resilience and stability over extreme temperatures (~2ppm).

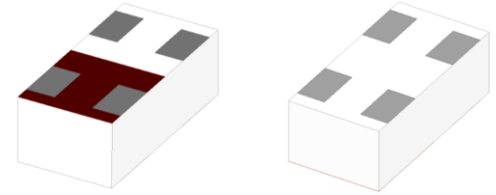

Recommended mounting locations for this antenna

PCB Center-edge



General Specifications^{1 2}

Frequency Range (MHz)	2400 - 2480
Impedance (Ω)	50
Return Loss (dB)	6.0 Min.
Peak Gain (dBi)	1.0 Typ.
Average Gain (dBi)	-1.5 Typ.
Ave. Radiated Efficiency (%)	58 Typ.

Maximum Ratings

Power Capacity (W)	2 Max. (CW)
Operating Temperature ($^{\circ}\text{C}$)	-40 to +105
Recommended Storage Conditions post-installation ($^{\circ}\text{C}$)	-40 to +105
Recommended Storage Conditions and Period for Unused T&R Product	45% - 75% RH +5 to +35 $^{\circ}\text{C}$ 18 Months Max.

¹ Typical value represents average measurement at 25 $^{\circ}\text{C}$. Min./Max. values represent measurements over specified operating temperature.

² General specifications measured on Johanson's evaluation board PN 2450AT07A0100001CE1.

Mechanical Dimensions

	Inches		Millimeters	
L	0.039	± 0.004	1.00	± 0.10
W	0.020	± 0.004	0.50	± 0.10
T	0.015	Max.	0.37	Max.
a	0.006	+0.004/-0.002	0.15	+0.1/-0.05
b	0.010	+0.004/-0.002	0.25	+0.1/-0.05
c	0.003	+0.004/-0.002	0.08	+0.1/-0.05

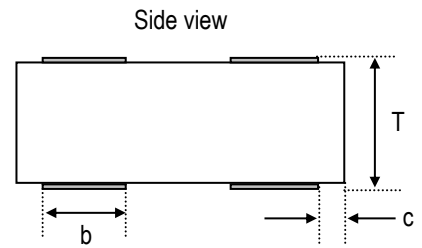
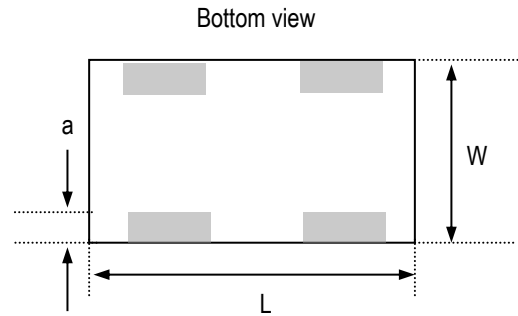

Terminal Configuration³

Pin Number	Function
1	Feed
2	GND
3	GND
4	Feed

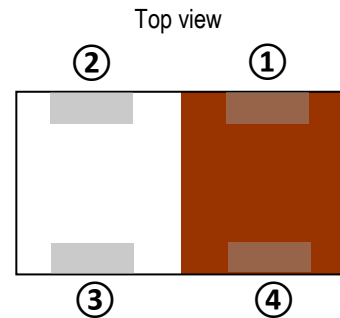

³ The termination type is Nickel/Tin. Go to: <https://www.johansontechnology.com/ipcsoldering-profile> for Typical Soldering Profile.

Evaluation Board and Recommended Mounting Configuration (P/N 2450AT07A0100001CE1)

All units in mm

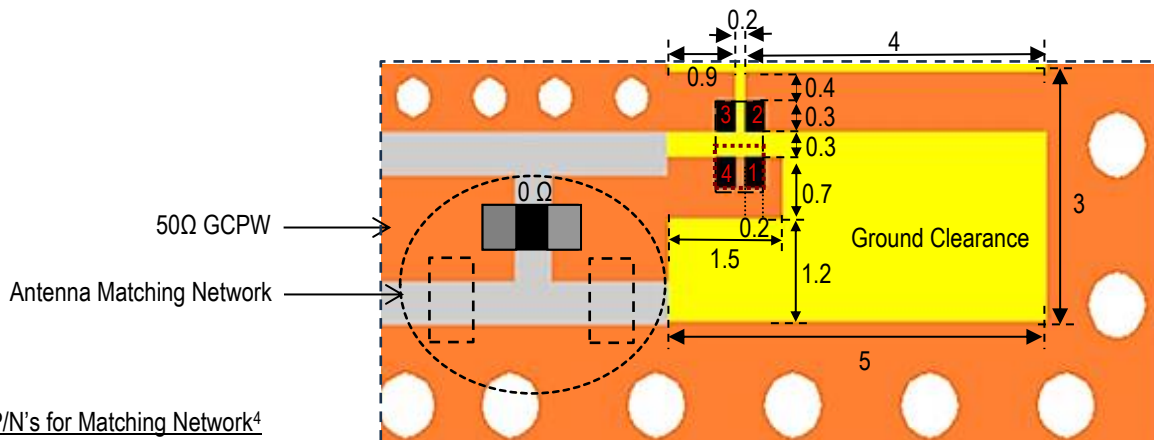
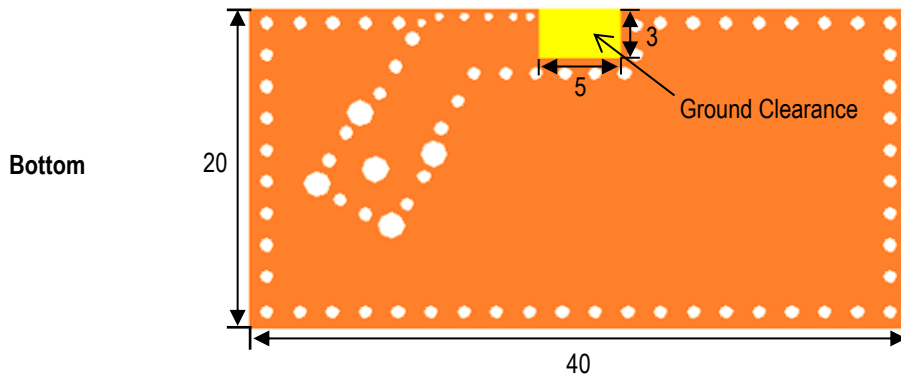
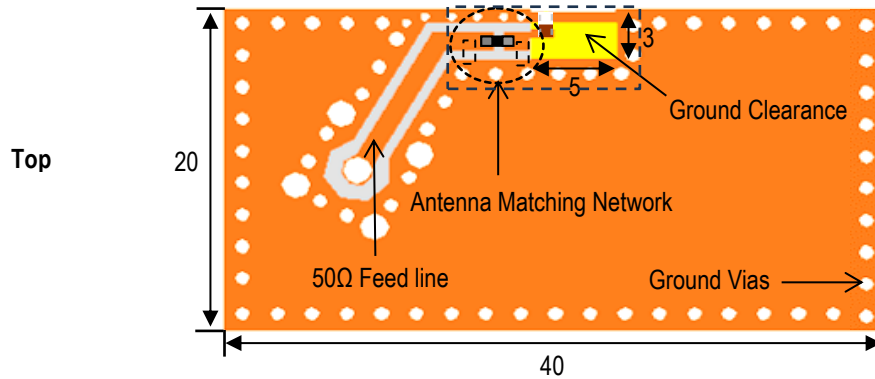

JTI P/N's for Matching Network⁴
N/A

*Note: Ground Vias are highly recommended to have better antenna efficiency.

If you'd like the CAD PCB layout or have any questions,
contact our application engineers at <https://www.johansontechnology.com/ask-a-question>

⁴ It is recommended that the designer leave available slots for a "pi" (or shunt-series-shunt) network. The antenna matching network values above are used when antenna is mounted on Johanson's evaluation board. The matching values on client's PCB will be different, depending on the layout, thickness, material, etc. Go to: <https://www.johansontechnology.com/tuning> and see how to obtain the new values.

Evaluation Board Return Loss Measurement (P/N 2450AT07A0100001CE1)

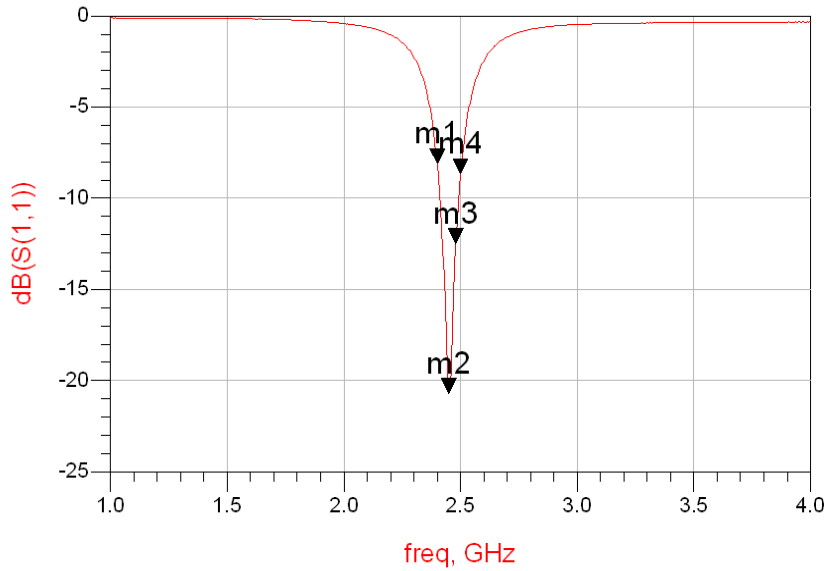

m1
freq=2.400GHz
dB(S(1,1))=-8.095

m2
freq=2.450GHz
dB(S(1,1))=-20.709

m3
freq=2.480GHz
dB(S(1,1))=-12.474

m4
freq=2.500GHz
dB(S(1,1))=-8.637

Evaluation Board 2D Radiation Patterns @2.44GHz (P/N 2450AT07A0100001CE1)

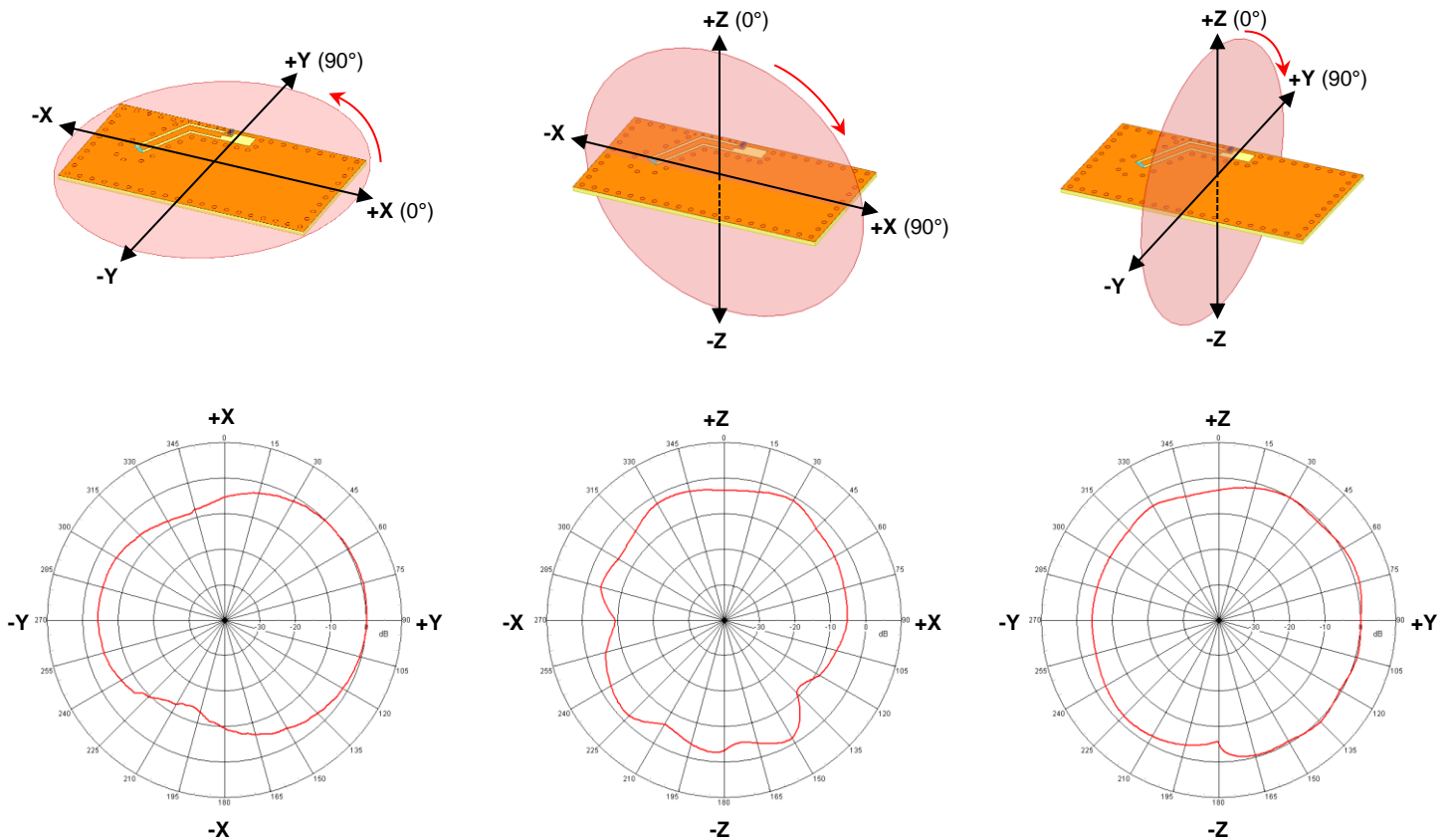

Tape and Reel Specification (Units in mm)

Tape Dimensions

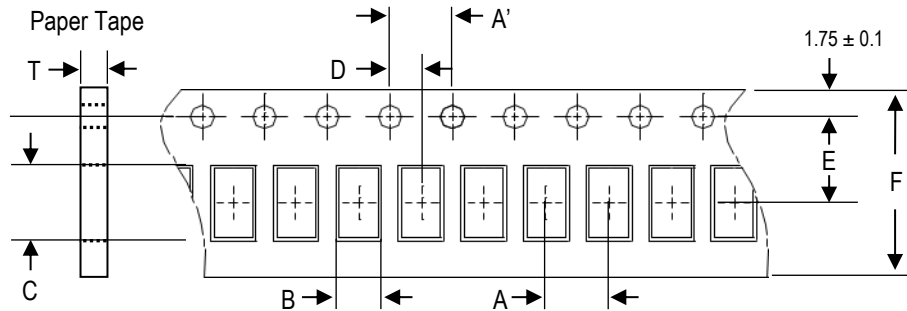

A	A'	B	C	D	E	F	T	Quantity/reel	Tape material
2.0±0.05	4.0±0.1	0.62±0.03	1.12±0.03	2.0±0.05	3.5±0.05	8.0±0.1	0.43±0.03	10,000pcs.	Paper

Reel Dimensions

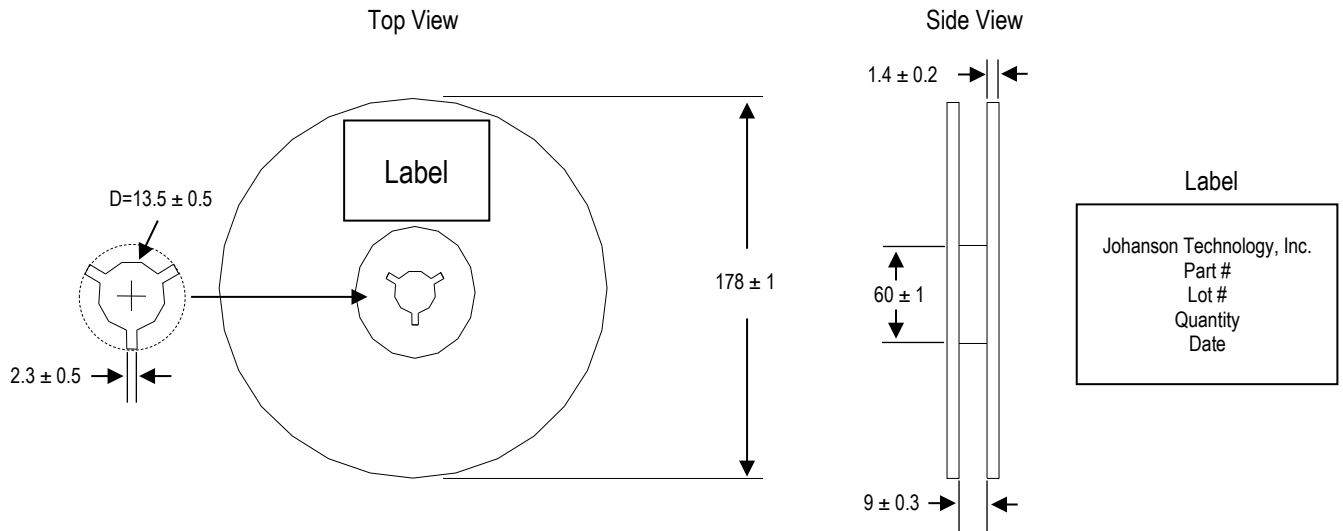

Leader and Trailer Dimensions

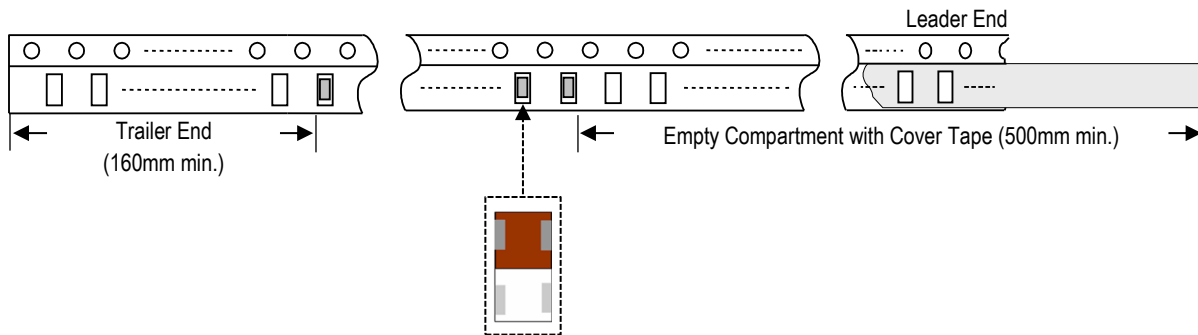

Orderable Part Number

Packaging Style	Part Number	Termination
Bulk (loose pcs.)	2450AT07A0100002B	Nickel Tin
T & R (7" Reel Paper Tape)	2450AT07A0100002T (Qty: 10,000 pcs./reel)	
Evaluation Board with 1 SMA Connector	2450AT07A0100001CE1	

Important Links

[2450AT07A0100002T Product Page](#)

[More RF Chip Antennas](#)

[Antenna Tuning, Optimization, and Validation Services](#)

[Soldering Information](#)

[MSL Information](#)

[Packaging Information](#)

[Recommended Storage Condition and Max Shelf Life](#)

[RoHS Compliance](#)

Contact our application engineers for a PCB layout review.

**Johanson Technology, Inc. reserves the right to make design changes without notice.
All sales are subject to Johanson Technology, Inc. terms and conditions.**