

Mounting Guidelines, GNSS, Selection Info, & Optimization Process

Antenna Mounting Guidelines

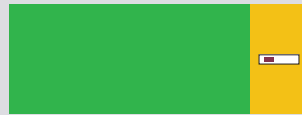

PCB End Mounting

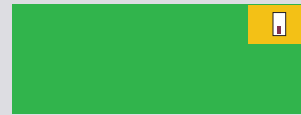

PCB Corner Mounting

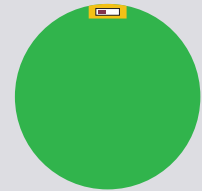

PCB Circular Mounting



PCB Center-Edge Mounting

Legend

	Antenna Chip		Mounting Area
	PC Board		

Selection Guide Information:

Note: Refer to the website for latest version of selection guide

Antenna Chip Selection Guide is a useful tool early in the design process when a decision on which Johanson antenna chip/s will be selected.

First, the designer must choose what type of layout is desired based on the product shape and remove allowable antenna chip placement.

The mounting plays a critical role in antenna chip selection.

It is important that the designer understands that the "**Antenna Optimization Process**" is composed of the following:

All four of these features work together to determine the final system performance. As such, changes to the **no-ground area** or **chip locations** relative to the edge of the circuit board can result in substandard performance.

Once the layout type has been selected, then determine the application type and associated **operational frequency**.

In some cases, the selection guide will provide two antenna chip options. We have identified features that should lead the designer to a specific selection.

Antenna Optimization Process

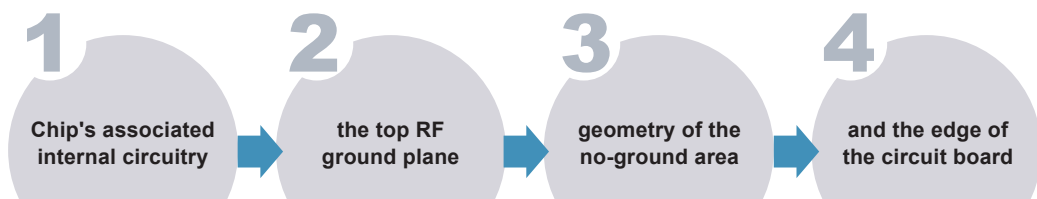

Note: Refer to the website for latest version of selection guide

RESOURCE ► <https://www.johansontechnology.com/chip-antenna-selection>

Application Legend & Bluetooth / Wi-Fi / Zigbee Applications

Antenna Selection Guide Tool



An easy to use, step-by-step tool to help you get the correct antenna chip part number, for your project design.



Legend

■ Application Type

1. Bluetooth / Wi-Fi / Zigbee
2. Wi-Fi / UNII 1-3
3. GNSS
4. Sub-GHz ISM
5. Dual-Band
6. Ultra Wide-Band

■ Frequency

■ Mounting Location

■ Physical Size
Small / Medium / Large

□ Part Number Description

Note: Refer to the website for latest version of selection guide. See the resource link at bottom of this page.

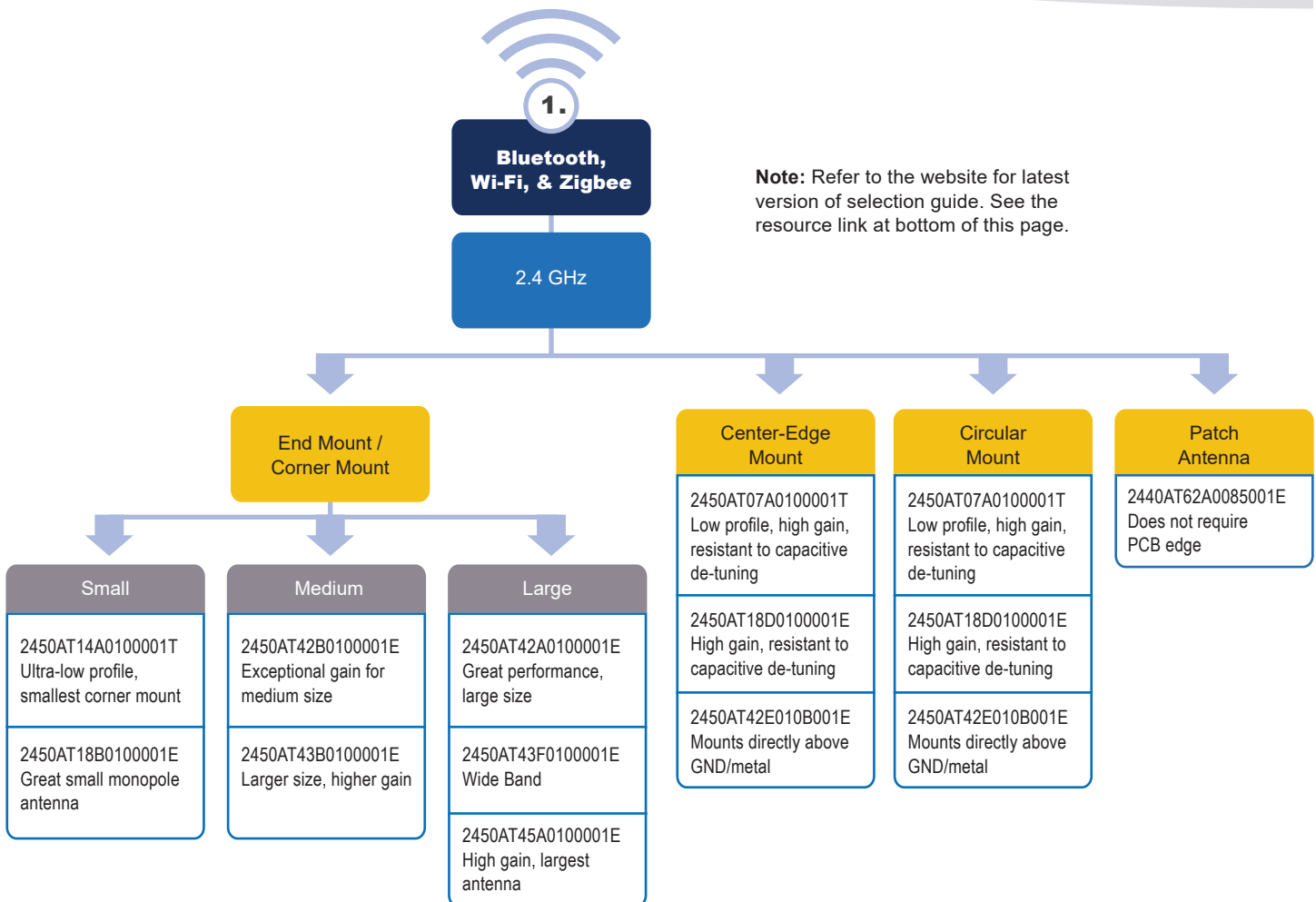

Note: Refer to the website for latest version of selection guide

<https://www.johansontechnology.com/chip-antenna-selection>

Antenna Chip Selection: Application, frequency, mount location, part number & description

Wi-Fi/UNII 1-3, GNSS, & Sub-GHz ISM

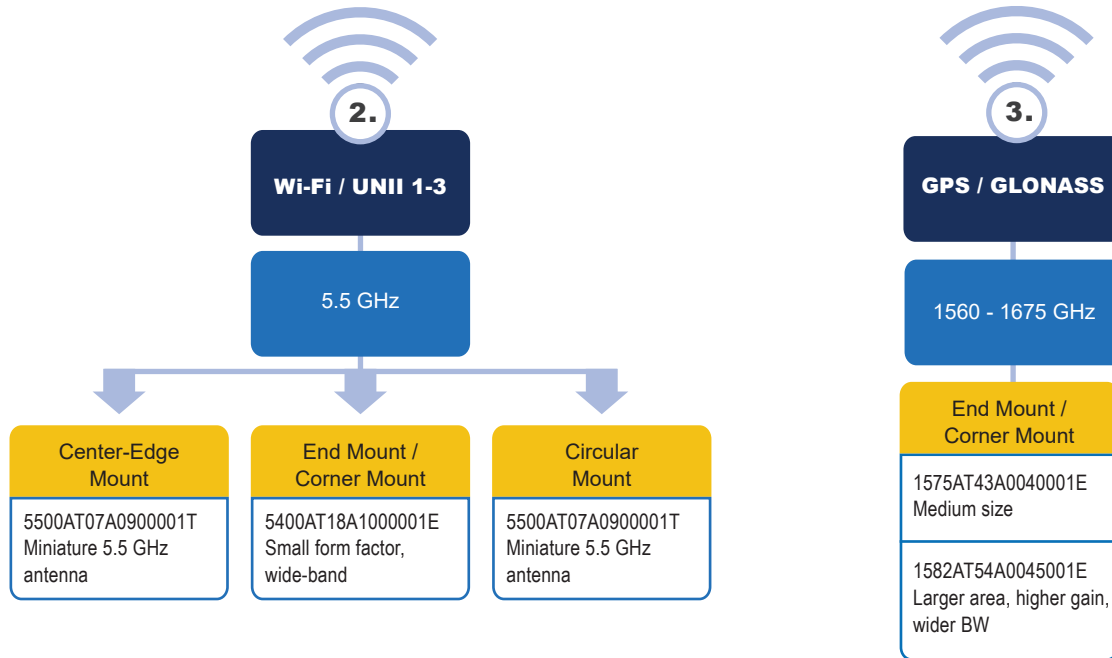

Note: Refer to the website for latest version of selection guide. See the resource link at bottom of this page.

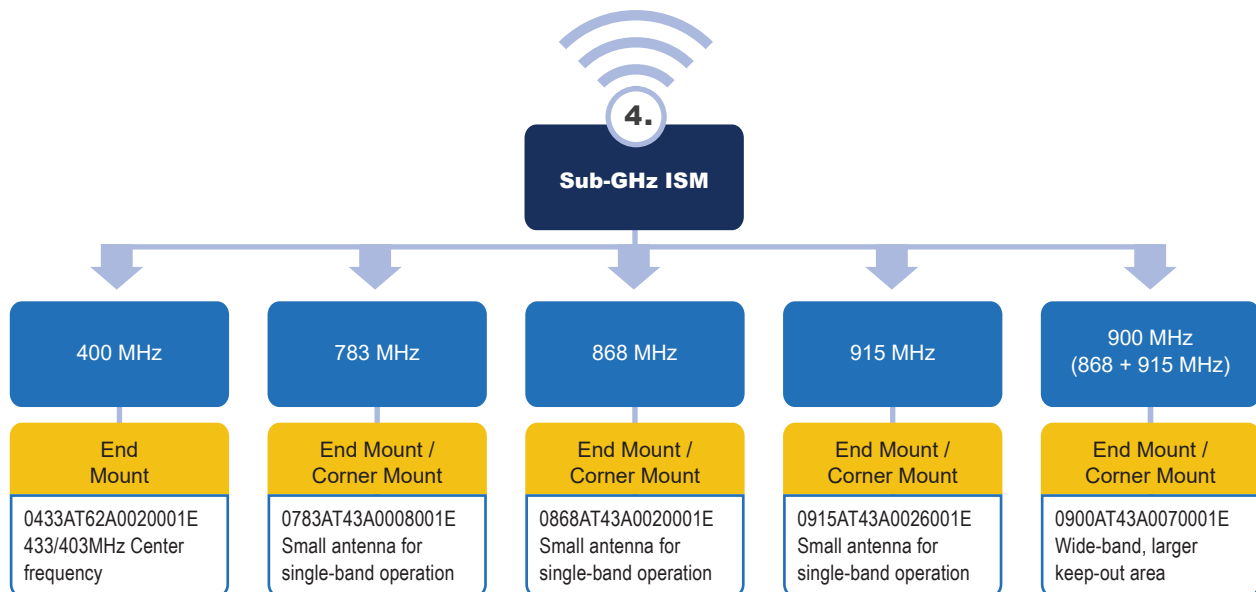

Note: Refer to the website for latest version of selection guide

RESOURCE ▶ <https://www.johansontechnology.com/chip-antenna-selection>

Dual-Band, & GNSS, Ultra Wide-Band Selections Applications

Note: Refer to the website for latest version of selection guide. See the resource link at bottom of this page.

