

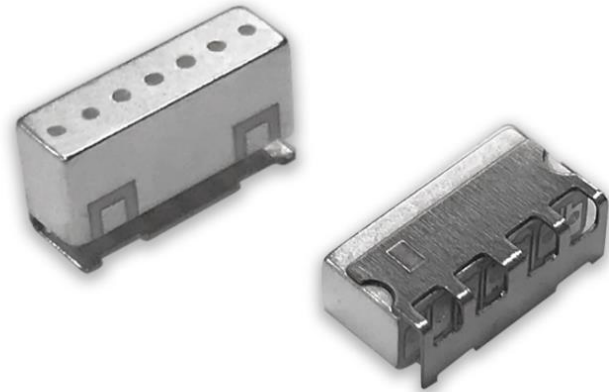

6.5 GHz WiFi 6E/7 Coexistence Filter

- Dielectric Resonator Type Filter
- 5925 - 7125 MHz pass band
- Low insertion loss
- High attenuation of Wi-Fi 5 GHz band
- 1W power capacity
- SMD type (9.4 x 4.6 x 3.0 mm)
- -40°C to +100°C operating temperature range
- RoHS compliant



General Specifications^{1 2}

Insertion Loss (dB)	5925 - 5945 MHz	3.3 Typ.	4.0 Max.
	5945 - 5955 MHz	2.6 Typ.	3.0 Max.
	5955 - 7125 MHz	2.3 Typ.	2.7 Max.
Return Loss (dB)	5925 - 5945 MHz	11 Typ.	10 Min.
	5945 - 5955 MHz		
	5955 - 7125 MHz		
Ripple (dB)	5925 - 5955 MHz	1.8 Typ.	2.0 Max.
	5955 - 6095 MHz		2.2 Max.
	6095 - 7125 MHz		2.5 Max.
Attenuation (dB)	500 - 5640 MHz		50 Min.
	5640 - 5835 MHz		45 Min.

Maximum Ratings

Power Capacity (W)	1 Max. (CW)
Operating Temperature (°C)	-40 to +100
Recommended Storage Conditions post-installation (°C)	-40 to +100
Recommended Storage Conditions and Period for Unused T&R Product ³	45% - 75% RH +5 to +35 °C 6 Months Max.

¹ Typical value represents average measurement at 25°C. Min./Max. values represent measurements over specified operating temperature.

² General specifications measured on Johanson's evaluation board P/N 6525BP49A1200001CE1.

³ 6 months max. in vacuum sealed bag and 1 week after opened. Please keep unused parts in vacuum sealed bags. If products are stored for more than 6 months, check for possible degradation in solderability. Please confirm solderability and characteristics of the products regularly.



Mechanical Dimensions

	Inches			Millimeters		
L	0.370	±	0.008	9.40	±	0.2
W	0.181		Max.	4.60		Max.
T	0.118	±	0.008	3.00	±	0.2
a	0.161	±	0.008	4.10	±	0.2
b	0.197	±	0.008	5.00	±	0.2
c	0.276	±	0.008	7.00	±	0.2
d	0.311	±	0.008	7.90	±	0.2
e	0.045	±	0.008	1.15	±	0.2
f	0.065	±	0.008	1.65	±	0.2
g	0.039	±	0.008	1.00	±	0.2

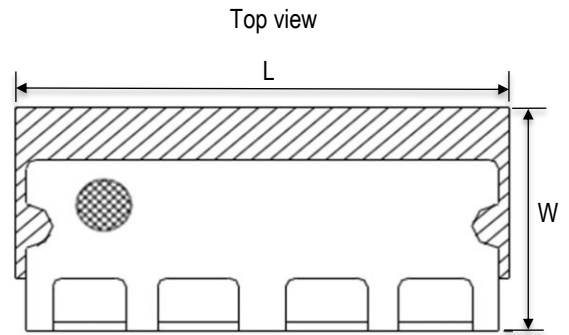
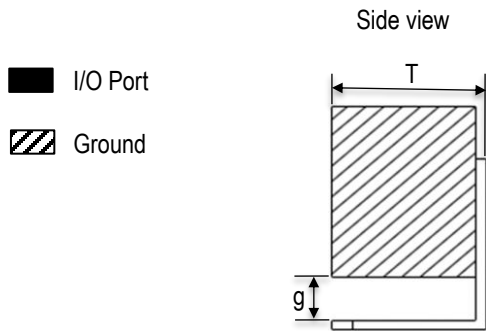
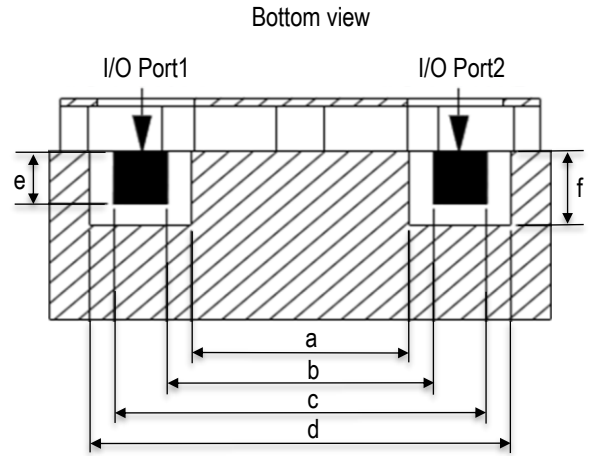

Terminal Configuration⁴

Pin Number	Function
1	INPUT/OUTPUT
2	INPUT/OUTPUT
3	GND

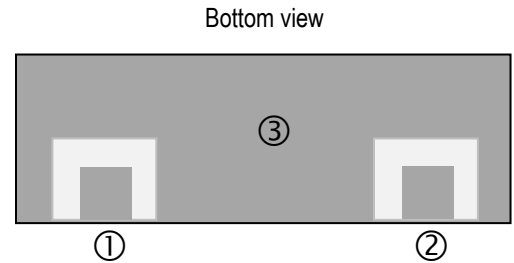



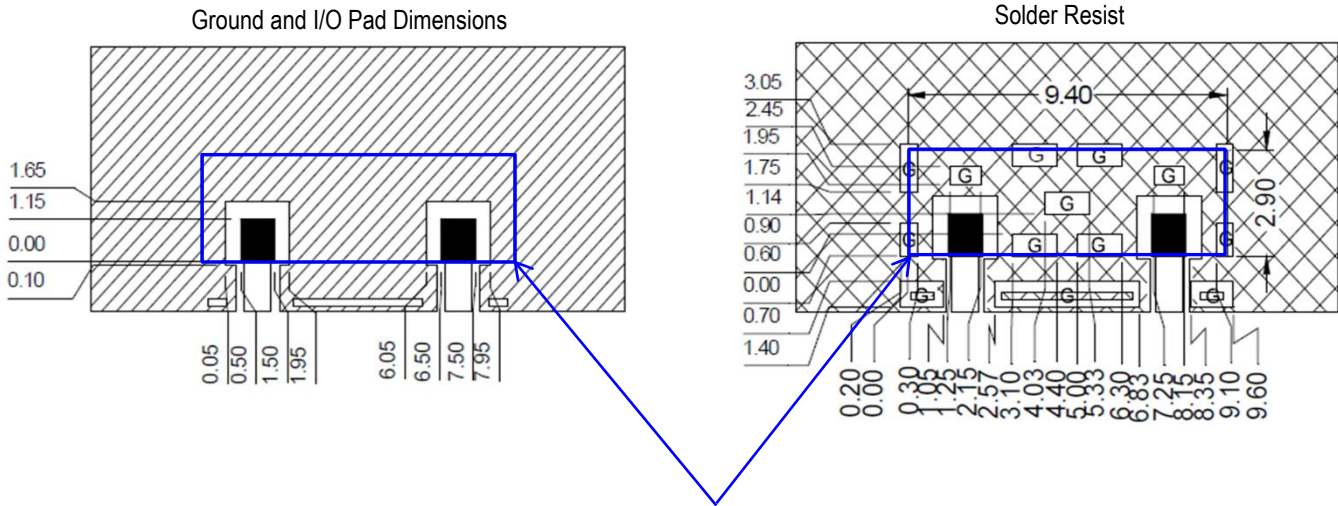

⁴ The termination type is Nickel Tin. Go to: <https://www.johansontechnology.com/ipcsoldering-profile> for Typical Soldering Profile.

Recommended PCB Layout

All units in mm



Blue rectangle represents the filter mounted onto pattern

-  I/O (Solder land)
-  Ground
-  Solder Resist Mask
-  Ground Pad

Shielding case

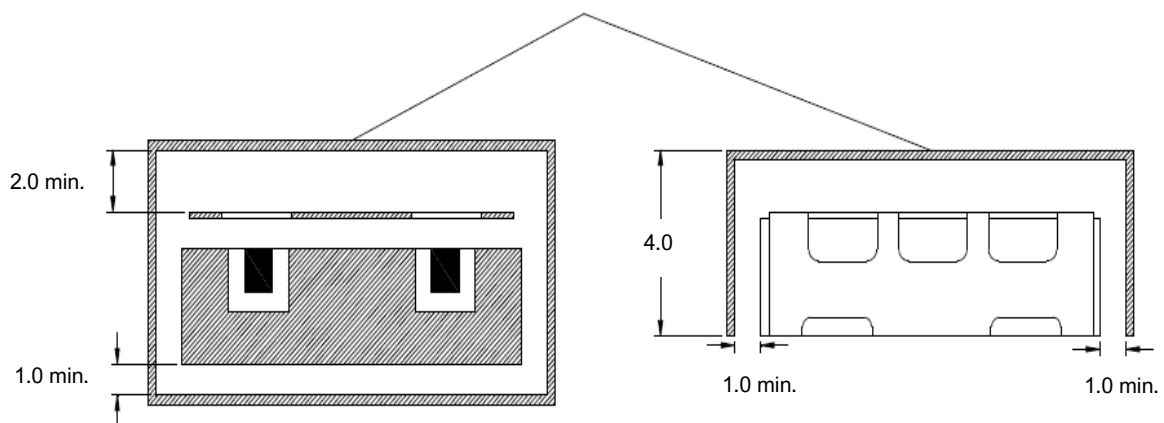

If you'd like the CAD PCB layout or have any questions, contact our application engineers at <https://www.johansontechnology.com/ask-a-question>

PCB Layers

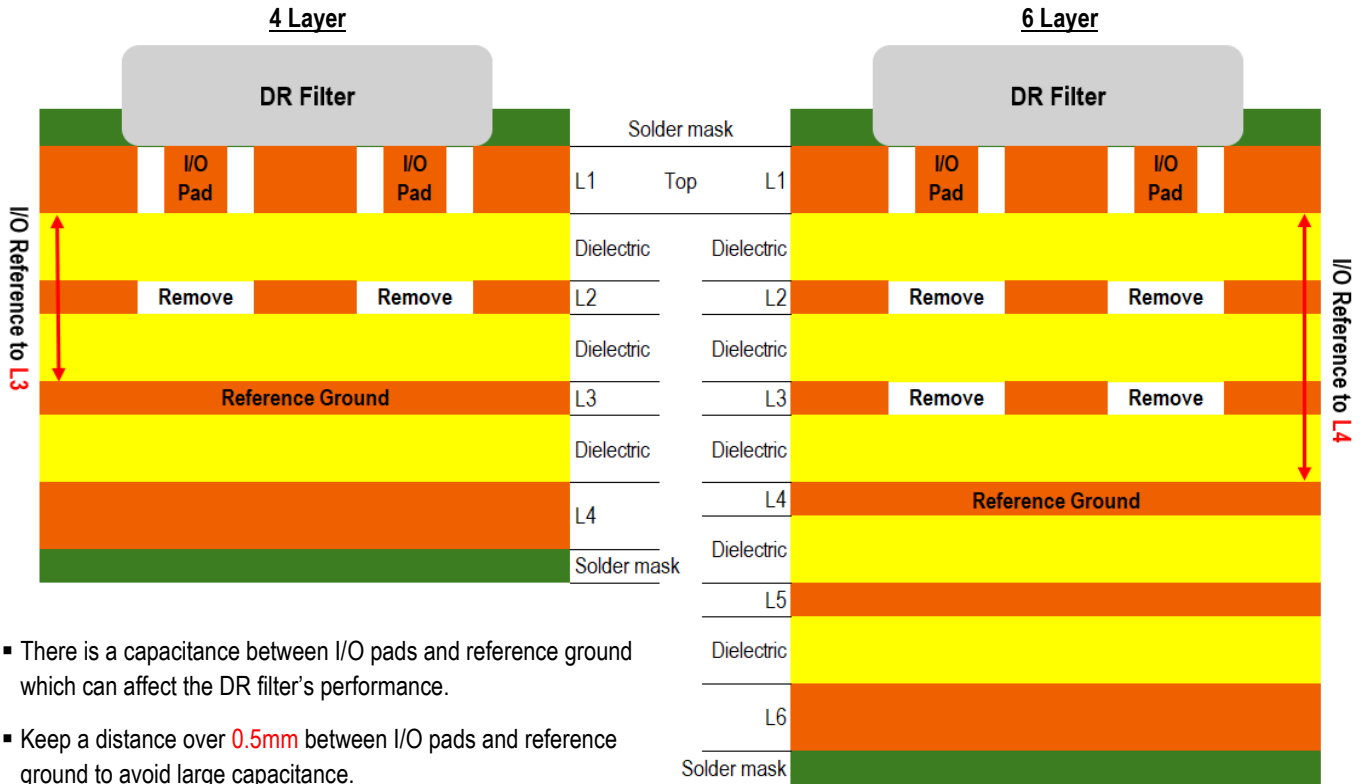

- There is a capacitance between I/O pads and reference ground which can affect the DR filter's performance.
- Keep a distance over **0.5mm** between I/O pads and reference ground to avoid large capacitance.

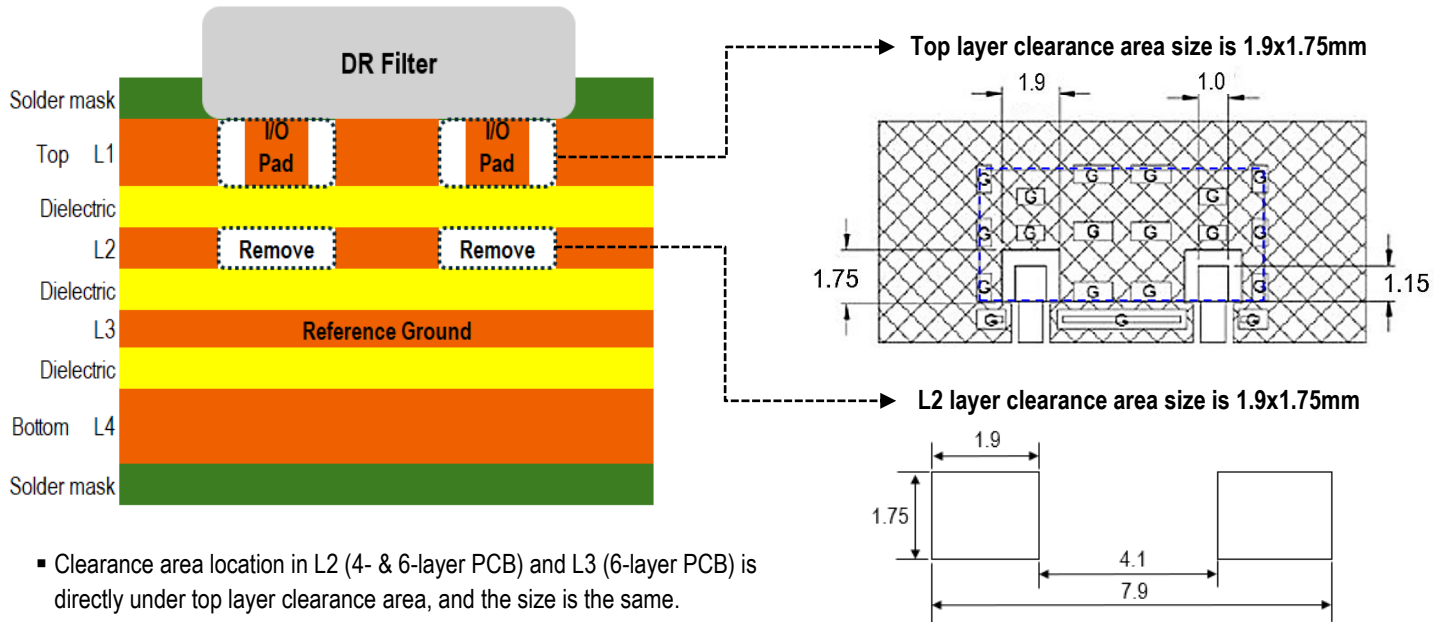

- Clearance area location in L2 (4- & 6-layer PCB) and L3 (6-layer PCB) is directly under top layer clearance area, and the size is the same.
- Reference ground under DR filter should avoid fragmented plane.

RF Measurement (T = 25°C)

Insertion Loss, Return Loss

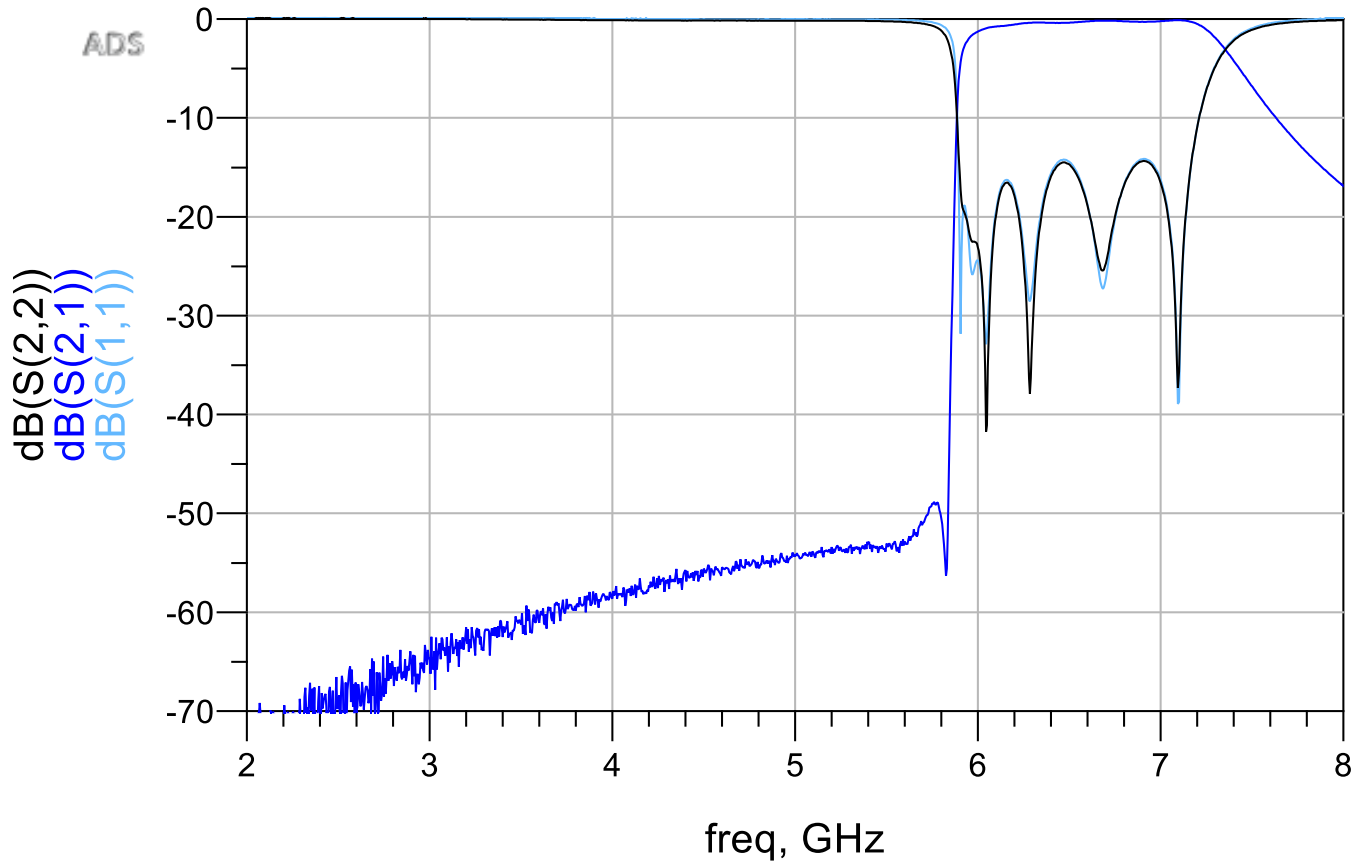

S-parameter and layout file available upon request. Please contact us at <https://www.johansontechnology.com/ask-a-question>

Tape and Reel Specification (Units in mm)

Tape Dimensions

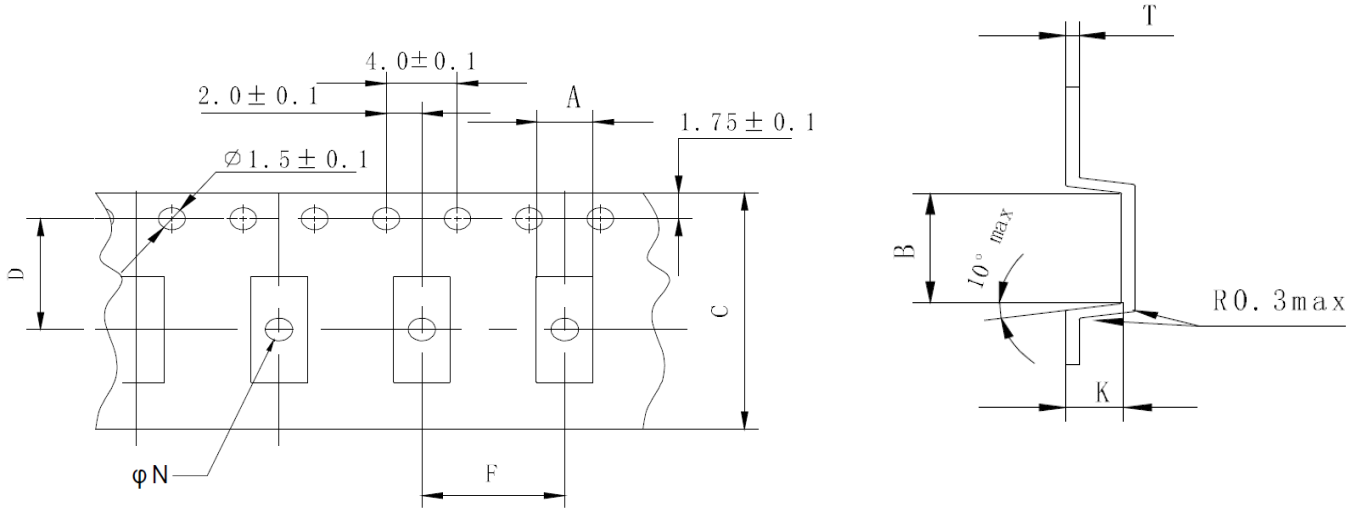

A	B	C	D	F	K	T	ϕN	Quantity/reel	Tape material
5.7±0.2	10.0±0.2	24.0±0.2	11.5±0.15	12.0±0.1	3.3±0.1	0.40±0.05	1.55±0.05	1,500pcs.	Plastic (Embossed)

Reel Dimensions

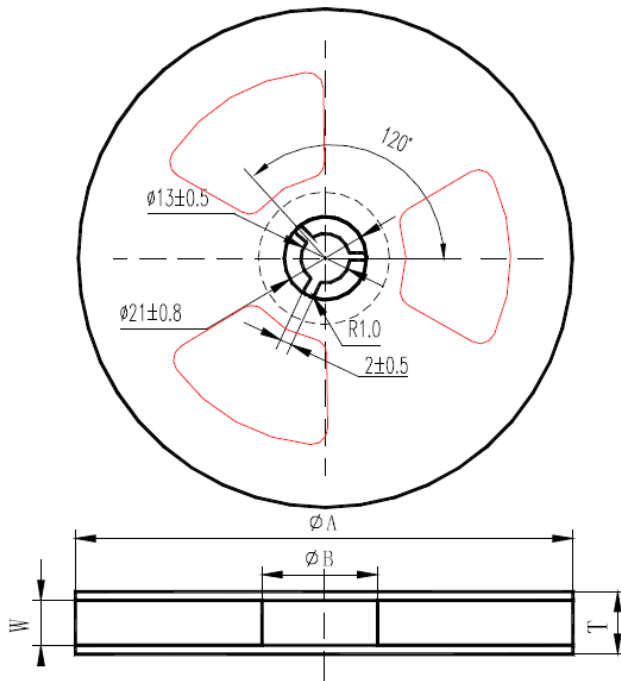

Label

Johanson Technology, Inc. Part # Lot # Quantity Date
--

ϕA	ϕB	W	T
330±3	80 Min.	24 Min.	26 Min.

Ordering Information

Packaging Style	Part Number	Termination
Bulk (loose pcs.)	6525BP49A1200001B	Nickel Tin
T & R (13" Reel Embossed Tape)	6525BP49A1200001U (Qty: 1,500 pcs./reel)	
Evaluation Board with 2 SMA Connectors	6525BP49A1200001CE1	

Important Links

[6525BP49A1200001U Product Page](#)

[More Band Pass Filters](#)

[Antenna Tuning, Optimization, and Validation Services](#)

[Soldering Information](#)

[MSL Information](#)

[Packaging Information](#)

[Recommended Storage Condition and Max Shelf Life](#)

[RoHS Compliance](#)

**Johanson Technology, Inc. reserves the right to make design changes without notice.
All sales are subject to Johanson Technology, Inc. terms and conditions.**