

2.45 GHz RF Chip Antenna

- 2.4 – 2.5 GHz Operational frequency
- Bluetooth, WLAN
- SMD, 7.0x2.0x1.2mm (LxWxT)
- End and corner mount
- RoHS compliant and AEC-Q200 Qualified available

Johanson Technology, Inc. (JTI) miniature RF ceramic chip antennas are made using Low Temperature Co-fired Ceramic (LTCC) technology which has the ability to embed low and high dielectric constants inside our antenna. This enables our components to have high detuning resilience and stability over extreme temperatures (~2ppm).

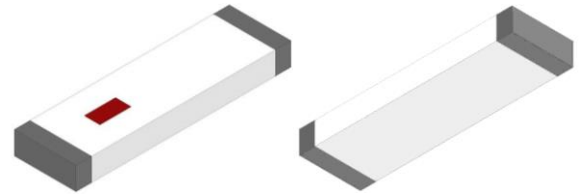

Recommended mounting locations for this antenna



General Specifications^{1 2}

Operational Frequency (MHz)	2400 - 2500
Impedance (Ω)	50
Return Loss (dB)	9.5 Min.
Peak Gain (dBi)	3.0 Typ.
Average Gain (dBi)	-1.6 Typ.
Average Radiated Efficiency (%) – EVB1 (Vertical)	72
Average Radiated Efficiency (%) – EVB2 (Horizontal)	69

Maximum Ratings

Power Capacity (W)	2 Max. (CW)
Operating Temperature ($^{\circ}\text{C}$)	-40 to +85
Recommended Storage Conditions post-installation ($^{\circ}\text{C}$)	-40 to +85
Recommended Storage Conditions and Period for Unused T&R Product	45% - 75% RH +5 to +35 $^{\circ}\text{C}$ 18 Months Max.

¹ Typical value represents average measurement at 25 $^{\circ}\text{C}$. Min./Max. values represent measurements over specified operating temperature.

² General specifications measured on Johanson's evaluation board P/N 2450AT43A0100001CE1.

Mechanical Dimensions

	Inches			Millimeters		
L	0.276	±	0.008	7.00	±	0.20
W	0.079	±	0.008	2.00	±	0.20
T	0.047	+0.004/-	0.008	1.20	+0.10/-	0.20
a	0.020	±	0.012	0.50	±	0.30

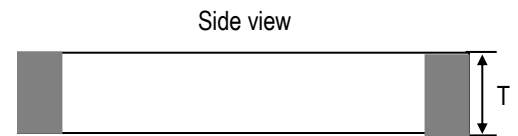
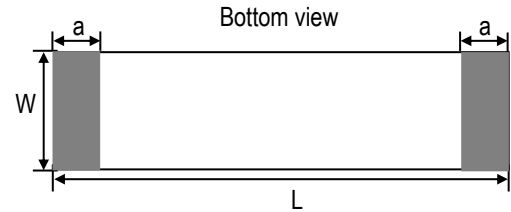

Terminal Configuration³

Pin Number	Function
1	Feed
2	NC*

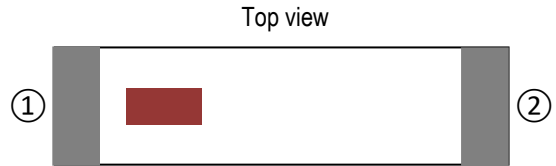

³ The termination type is Nickel Tin. Go to: <https://www.johansontechnology.com/ipcsoldering-profile> for Typical Soldering Profile.

* This terminal must be soldered for anchoring and mechanical stability.

Evaluation Board and Recommended Mounting Configuration 1 (P/N 2450AT43A0100001CE1)

All units in mm

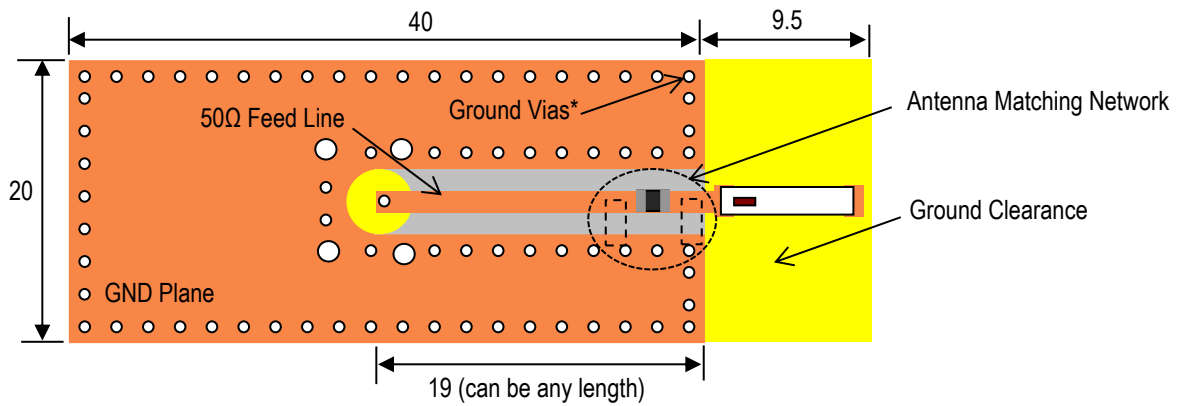

*Note: Ground Vias are highly recommended to have better antenna efficiency.

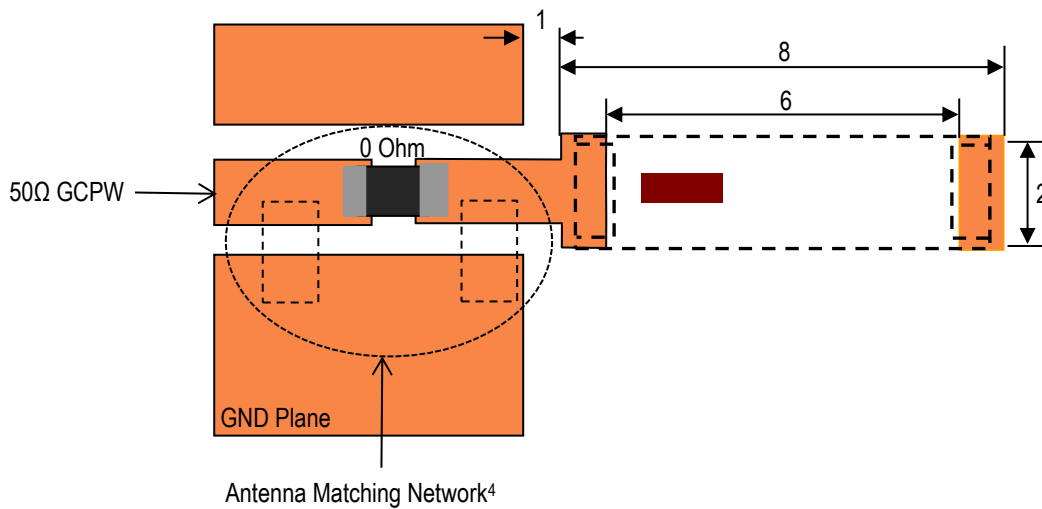

If you'd like the CAD PCB layout or have any questions, contact our application engineers at <https://www.johansontechnology.com/ask-a-question>

⁴ It is recommended that the designer leave available slots for a "pi" (or shunt-series-shunt) network. The antenna matching network values above are used when the antenna is mounted on Johanson's evaluation board. The optimal matching values will vary depending on the layout, thickness, material, etc. Go to: <https://www.johansontechnology.com/tuning> for more information.

Evaluation Board Typical Return Loss Measurement (P/N 2450AT43A0100001CE1)

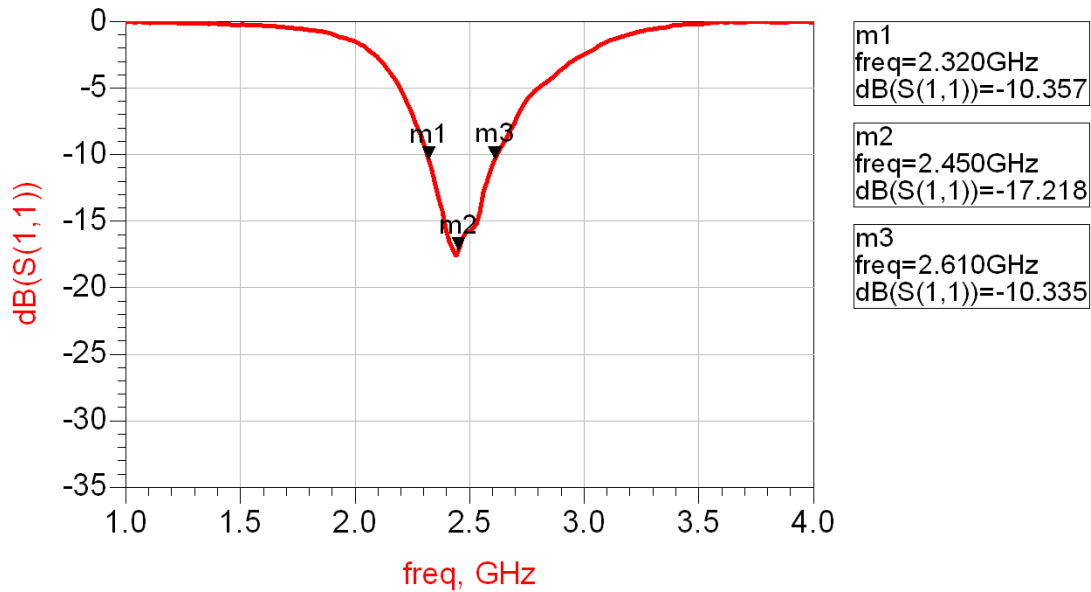

Evaluation Board Typical 2D Radiation Patterns @2450 MHz (P/N 2450AT43A0100001CE1)

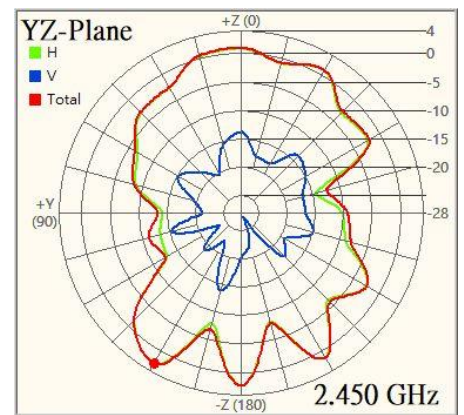
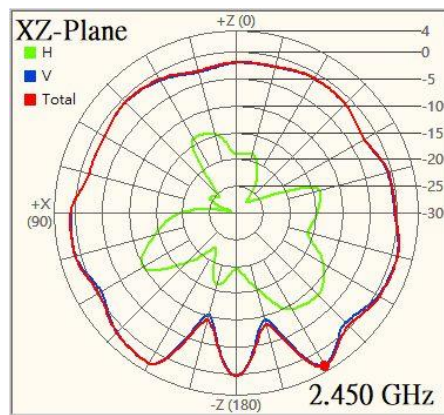
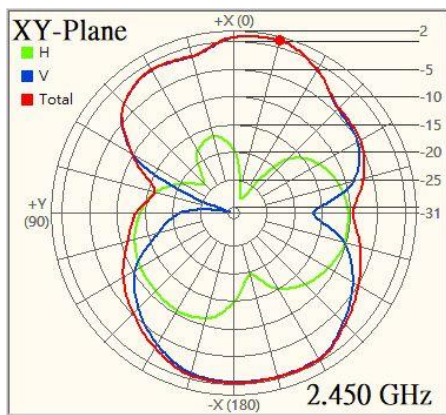
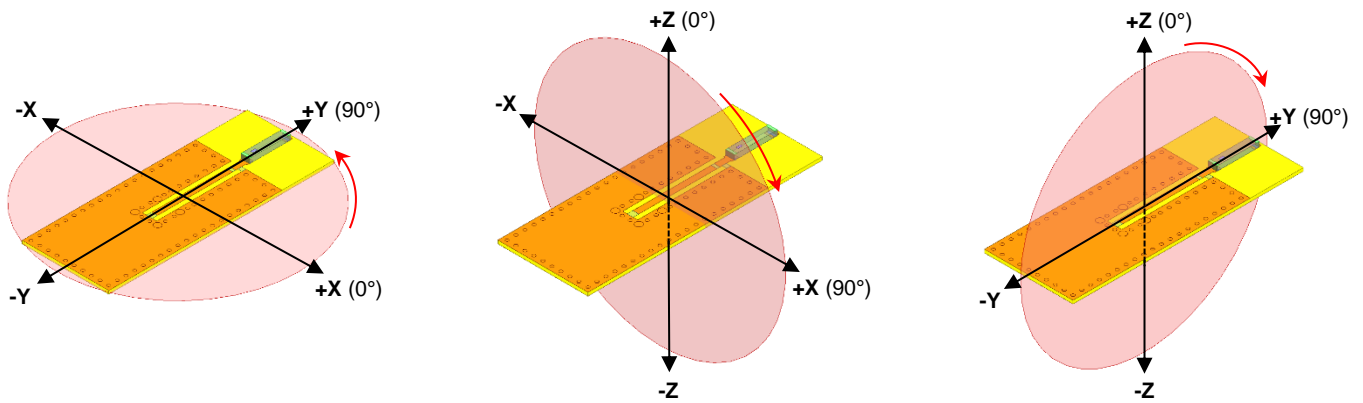

Evaluation Board and Recommended Mounting Configuration 2 (P/N 2450AT43A0100001CE2)

All units in mm

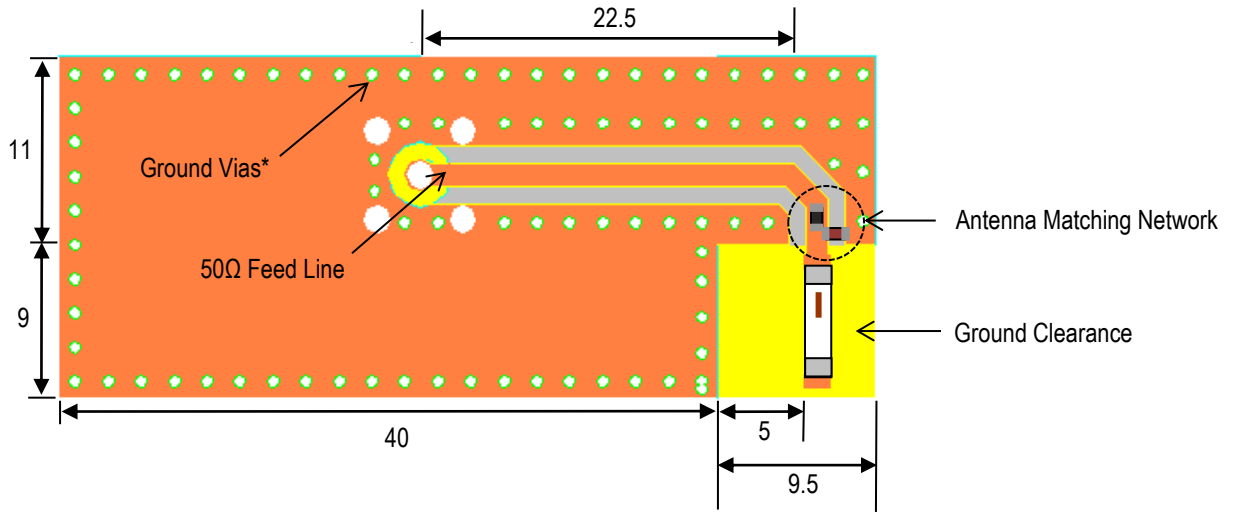

*Note: Ground Vias are highly recommended to have better antenna efficiency.

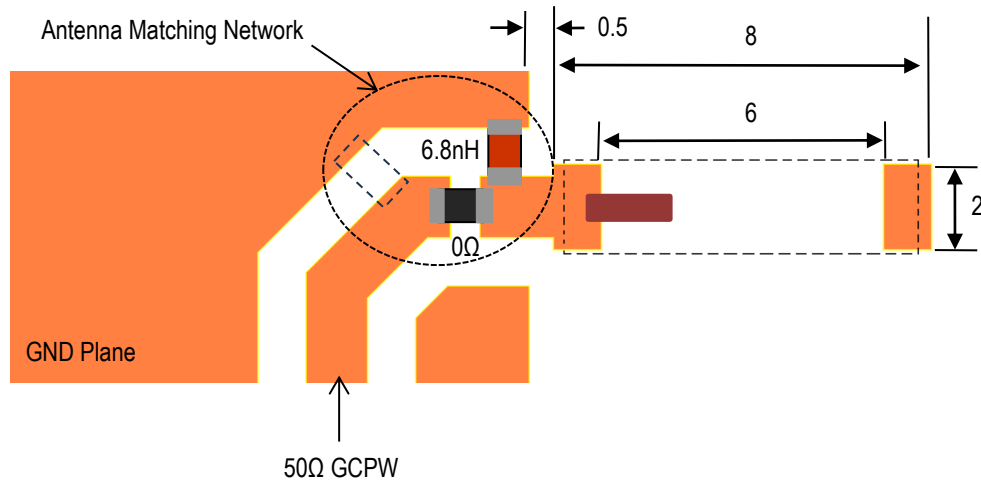

JTI P/N's for Matching Network⁵

Inductor (6.8nH): LRC0402CJ6N8GV001T

If you'd like the CAD PCB layout or have any questions,
contact our application engineers at <https://www.johansontechnology.com/ask-a-question>

⁵ It is recommended that the designer leave available slots for a "pi" (or shunt-series-shunt) network. The antenna matching network values above are used when antenna is mounted on Johanson's evaluation board. The matching values on client's PCB will be different, depending on the layout, thickness, material, etc. Go to: <https://www.johansontechnology.com/tuning> and see how to obtain the new values.

Evaluation Board Typical Return Loss Measurement (P/N 2450AT43A0100001CE2)

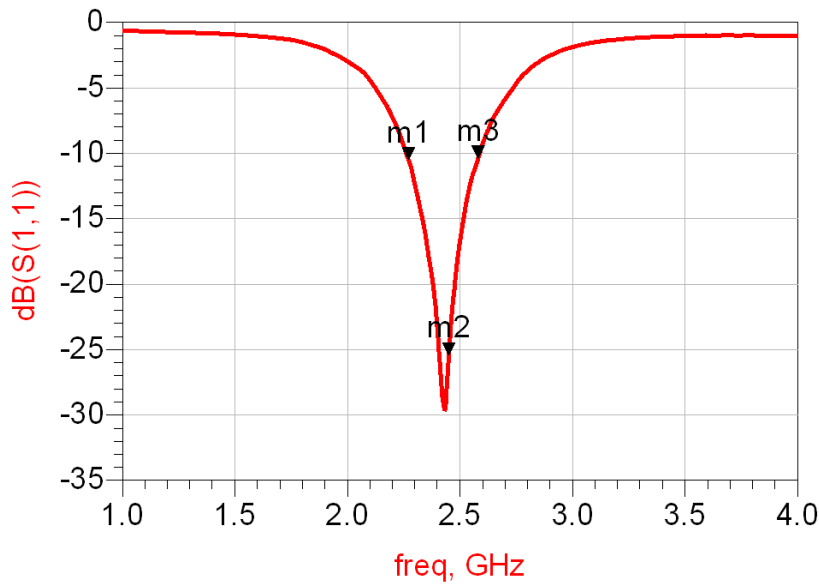

m1
freq=2.270GHz
dB(S(1,1))=-10.484

m2
freq=2.450GHz
dB(S(1,1))=-25.420

m3
freq=2.580GHz
dB(S(1,1))=-10.370

Evaluation Board Typical 2D Radiation Patterns @2450 MHz (P/N 2450AT43A0100001CE2)

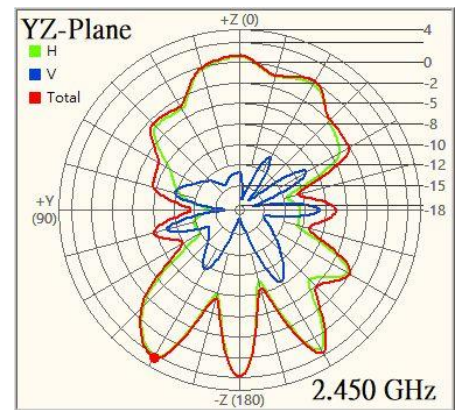
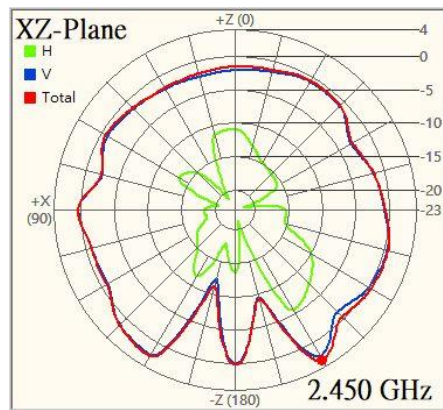
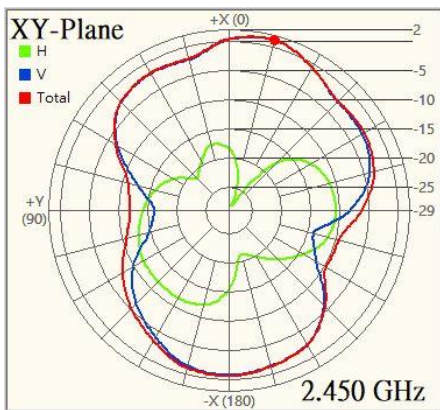
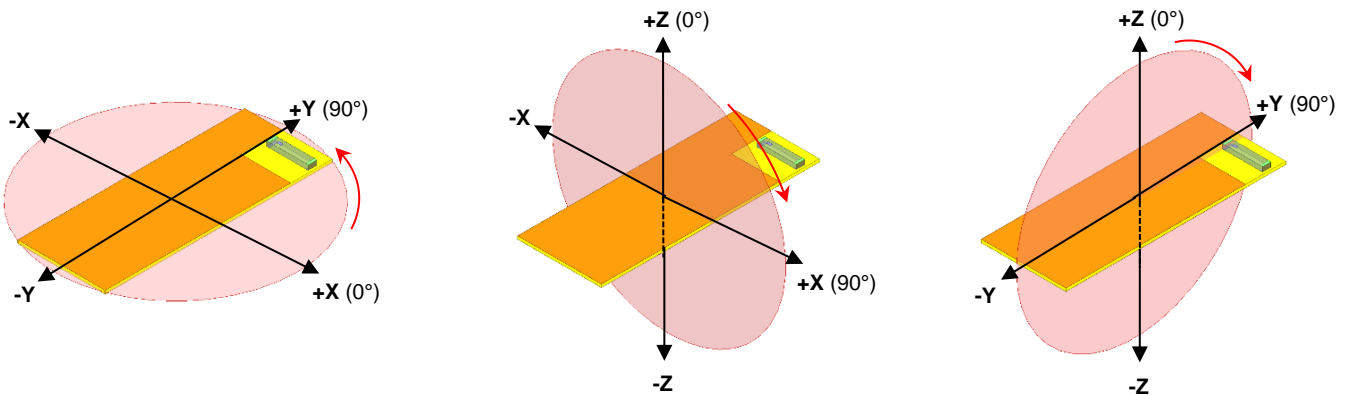

Tape and Reel Specification (Units in mm)

Tape Dimensions

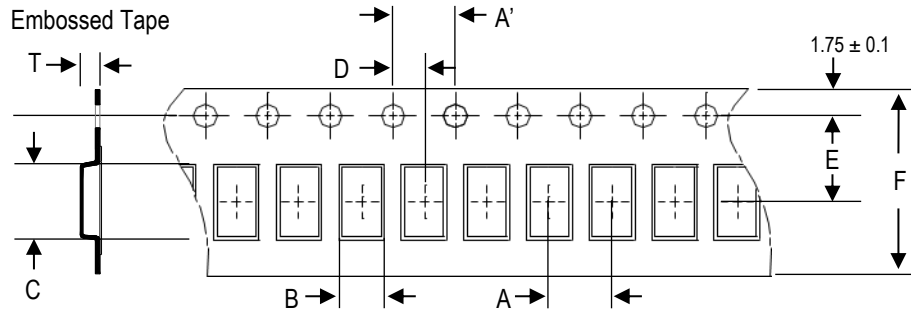

A	A'	B	C	D	E	F	T	Quantity/reel	Tape material
4.0 ± 0.1	4.0 ± 0.1	2.4 ± 0.1	7.3 ± 0.1	2.0 ± 0.05	5.5 ± 0.1	12.0 ± 0.1	1.45 ± 0.1	1,000pcs.	Plastic (Embossed)

Reel Dimensions

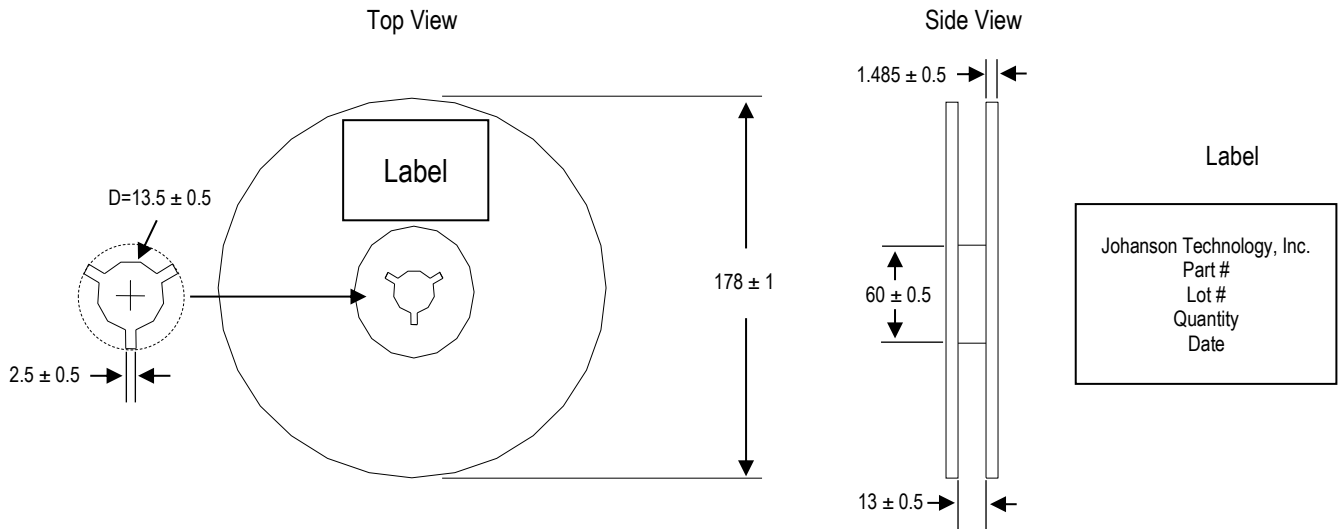

Leader and Trailer Dimensions

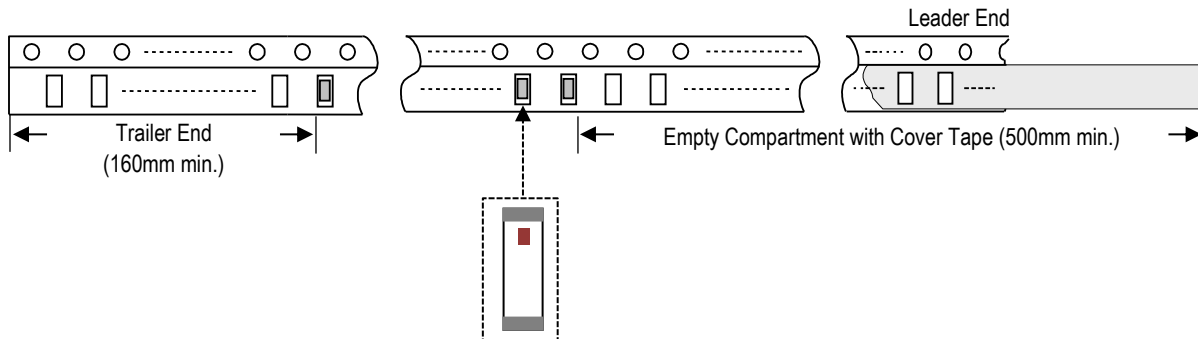

Orderable Part Number

Packaging Style	Part Number	Termination
Bulk (loose pcs.)	2450AT43A0100001B	Nickel Tin
T & R (7" Reel Embossed Tape)	2450AT43A0100001E (Qty: 1,000 pcs./reel)	
Evaluation Board with 1 SMA Connector (Vertical)	2450AT43A0100001CE1 (Page 3)	
Evaluation Board with 1 SMA Connector (Horizontal)	2450AT43A0100001CE2 (Page 5)	

Important Links

[2450AT43A0100001E Product Page](#)

[More RF Chip Antennas](#)

[Antenna Tuning, Optimization, and Validation Services](#)

[Soldering Information](#)

[MSL Information](#)

[Packaging Information](#)

[Recommended Storage Condition and Max Shelf Life](#)

[RoHS Compliance](#)

Contact our application engineers for a PCB layout review.

**Johanson Technology, Inc. reserves the right to make design changes without notice.
All sales are subject to Johanson Technology, Inc. terms and conditions.**