

## 2.45 GHz RF Chip Antenna, AEC-Q200 Qualified

- 2.4 – 2.5 GHz Operational frequency
- Bluetooth, WLAN
- SMD, 9.5x2.0x1.2mm (LxWxT)
- End and corner mount
- RoHS compliant

Johanson Technology, Inc. (JTI) miniature RF ceramic chip antennas are made using Low Temperature Co-fired Ceramic (LTCC) technology which has the ability to embed low and high dielectric constants inside our antenna. This enables our components to have high detuning resilience and stability over extreme temperatures (~2ppm).

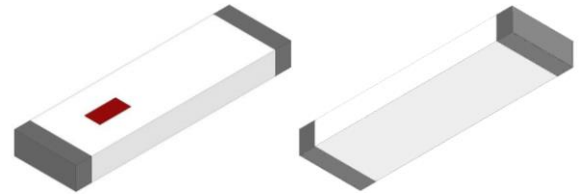

Recommended mounting locations for this antenna



### General Specifications<sup>1 2</sup>

| Operational Frequency (MHz)     | 2400 – 2500                               |   |   |
|---------------------------------|---|---|---|
| Impedance ( $\Omega$ )          | 50  |   |   |
|                                 | Mounting Configuration 1<br>See pages 3-4 | Mounting Configuration 2<br>See pages 5-6 | Mounting Configuration 3<br>See pages 7-8 |
| Return Loss (dB)                | 9.5 Min.                                  | 9.5 Min.                                  | 9.5 Min.                                  |
| Peak Gain (dBi)                 | 2.2 Typ.                                  | 1.5 Typ.                                  | 1.3 Typ.                                  |
| Average Gain (dBi)              | 1.0 Typ.                                  | 0.0 Typ.                                  | 0.6 Typ.                                  |
| Average Radiated Efficiency (%) | 97  | 92  | 91  |

### Maximum Ratings

|   |  |
|---|--|
| Power Capacity (W)  | 3 Max. (CW)  |
| Operating Temperature ( $^{\circ}\text{C}$ )                            | -40 to +105  |
| Recommended Storage Conditions post-installation ( $^{\circ}\text{C}$ ) | -40 to +105  |
| Recommended Storage Conditions and Period for Unused T&R Product        | 45% - 75% RH<br>+5 to +35 $^{\circ}\text{C}$<br>18 Months Max. |

<sup>1</sup> Typical value represents average measurement at 25 $^{\circ}\text{C}$ . Min./Max. values represent measurements over specified operating temperature.

<sup>2</sup> General specifications measured on Johanson's evaluation board P/Ns 2450AT45A0100001CE1, 2450AT45A0100001CE2, 2450AT45A0100001CE3.

**Mechanical Dimensions**

|          | Inches |               | Millimeters |             |
|----------|--------|---------------|-------------|-------------|
| <b>L</b> | 0.374  | ± 0.008       | 9.50        | ± 0.20      |
| <b>W</b> | 0.079  | ± 0.008       | 2.00        | ± 0.20      |
| <b>T</b> | 0.047  | +0.004/-0.008 | 1.20        | +0.10/-0.20 |
| <b>a</b> | 0.020  | ± 0.012       | 0.50        | ± 0.30      |

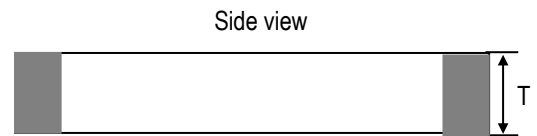
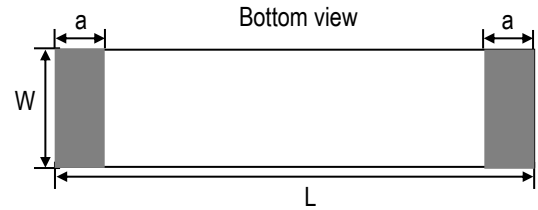

**Terminal Configuration<sup>3</sup>**

| Pin Number | Function |
|------------|----------|
| 1          | Feed     |
| 2          | NC*      |

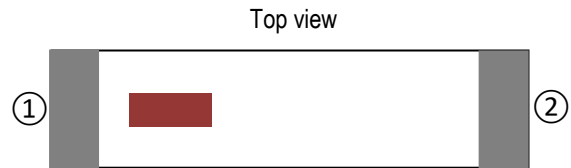

<sup>3</sup> The termination type is Nickel Tin. Go to: <https://www.johansontechnology.com/ipcsoldering-profile> for Typical Soldering Profile.

\* This terminal must be soldered for anchoring and mechanical stability.

**Evaluation Board and Recommended Mounting Configuration 1 (P/N 2450AT45A0100001CE1)**

All units in mm

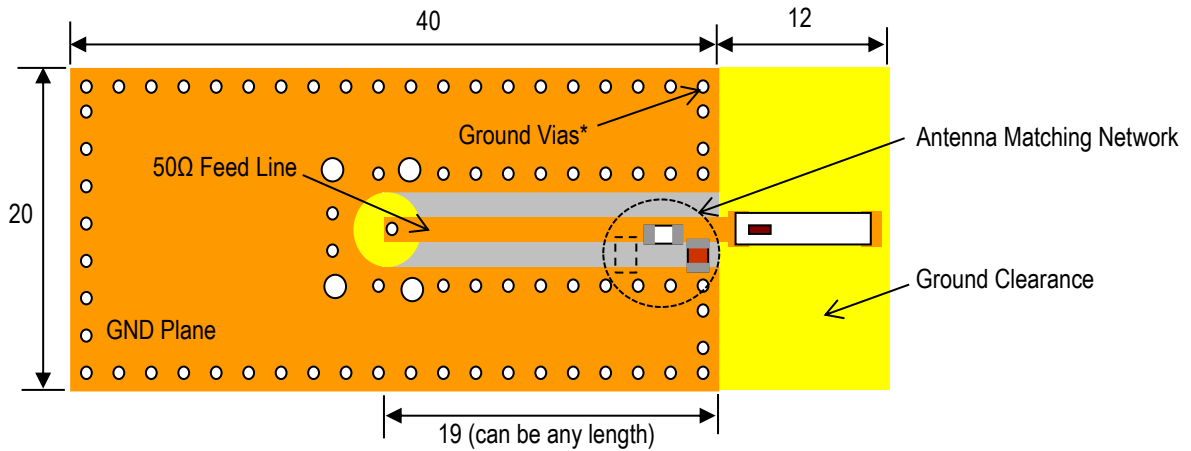

\*Note: Ground Vias are highly recommended to have better antenna efficiency.

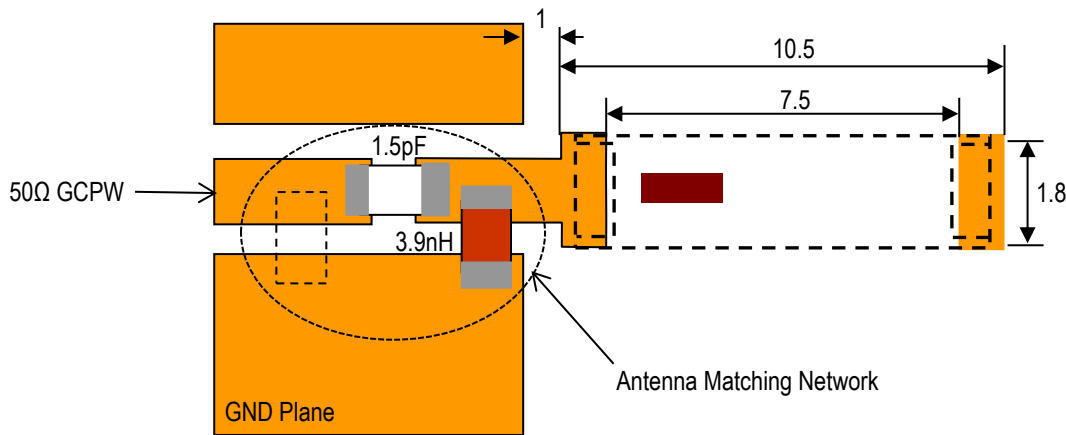

JTI P/N's for Matching Network<sup>4</sup>

Inductor (3.9nH): LRC0402CS3N9GV001T

Capacitor (1.5pF): QSCF500Q1R5B1GV001T

If you'd like the CAD PCB layout or have any questions,  
contact our application engineers at <https://www.johansontechnology.com/ask-a-question>

<sup>4</sup> It is recommended that the designer leave available slots for a "pi" (or shunt-series-shunt) network. The antenna matching network values above are used when antenna is mounted on Johanson's evaluation board. The matching values on client's PCB will be different, depending on the layout, thickness, material, etc. Go to: <https://www.johansontechnology.com/tuning> and see how to obtain the new values.

**Evaluation Board Typical Return Loss Measurement (P/N 2450AT45A0100001CE1)**

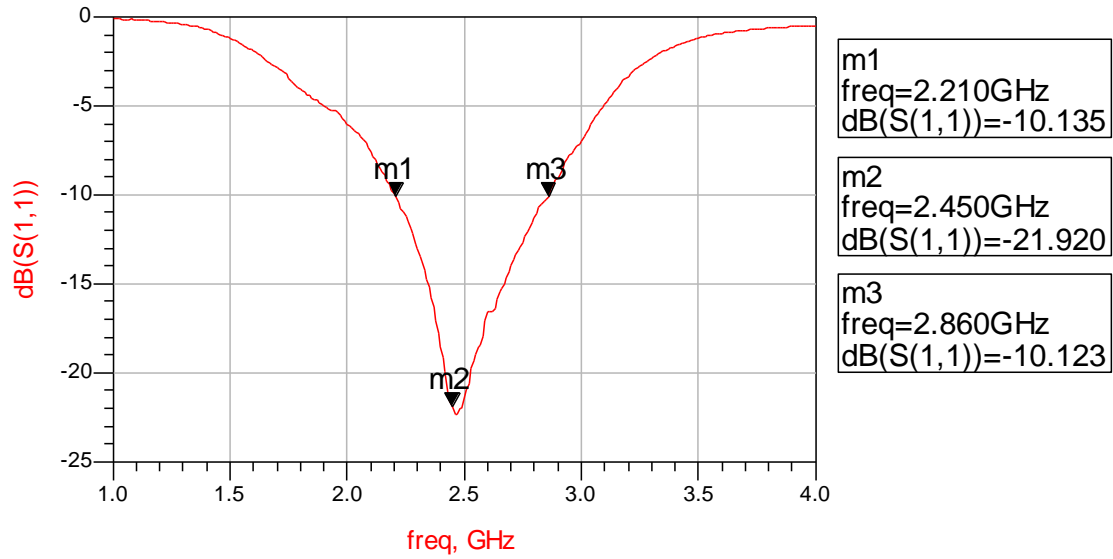

**Evaluation Board Typical 2D Radiation Patterns @2450 MHz (P/N 2450AT45A0100001CE1)**

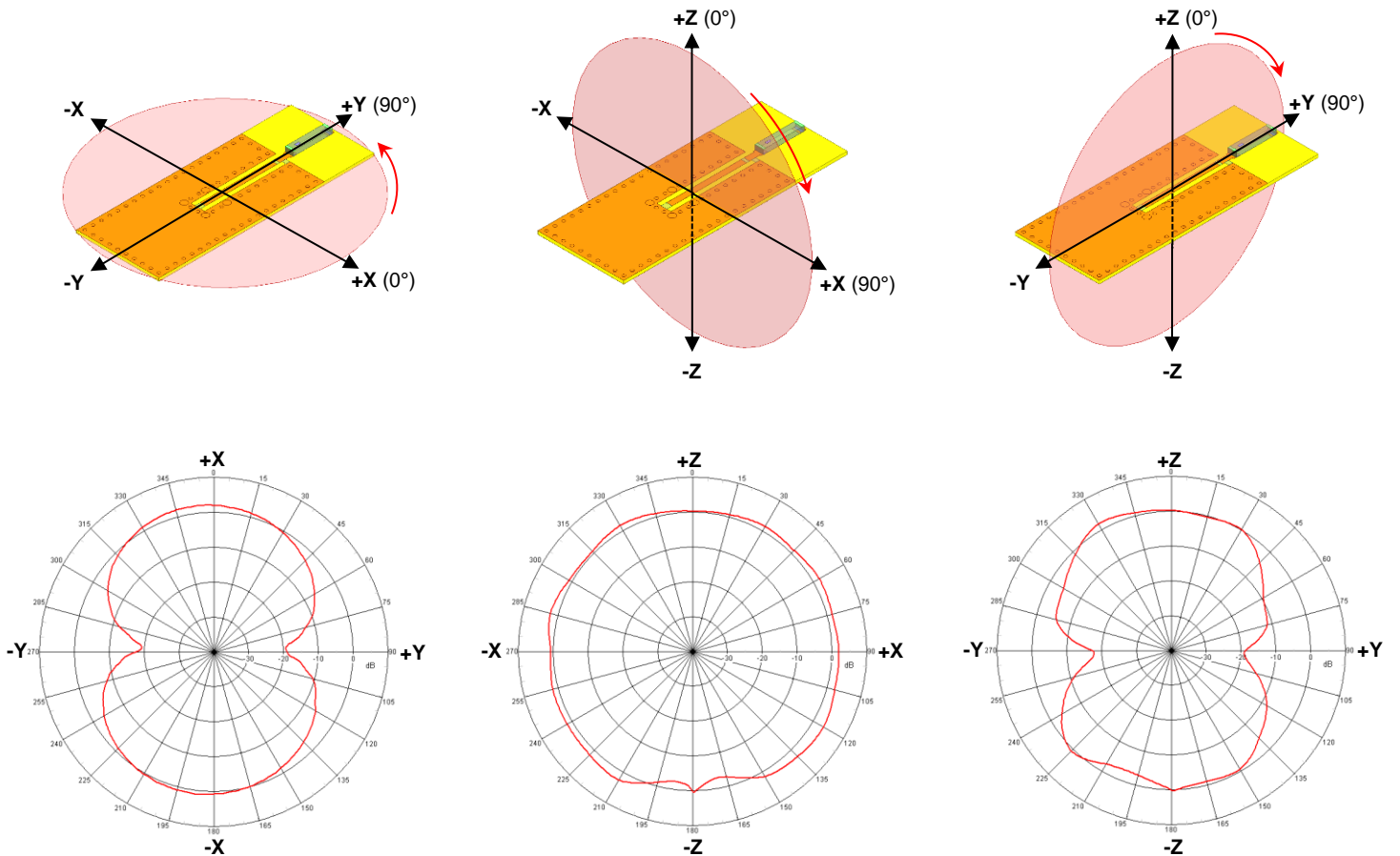

**Evaluation Board and Recommended Mounting Configuration 2 (P/N 2450AT45A0100001CE2)**

All units in mm

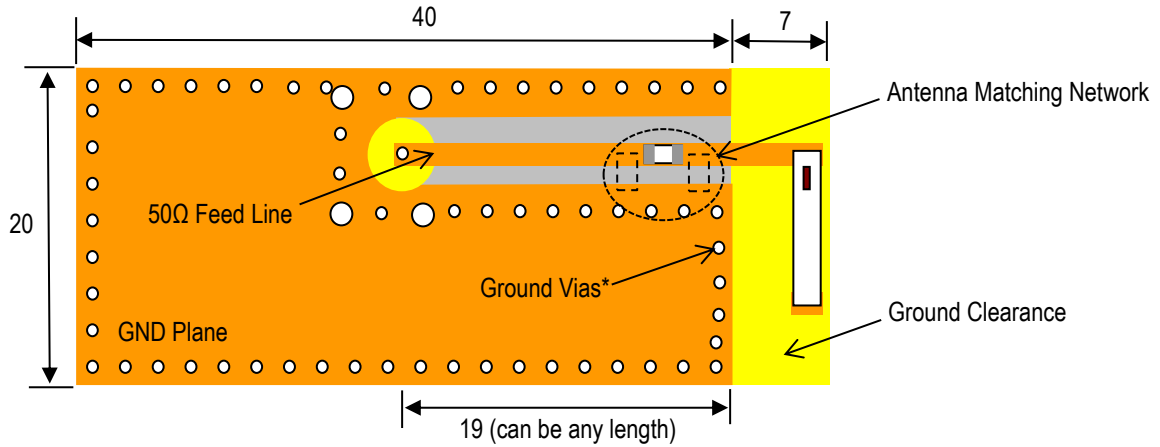

\*Note: Ground Vias are highly recommended to have better antenna efficiency.

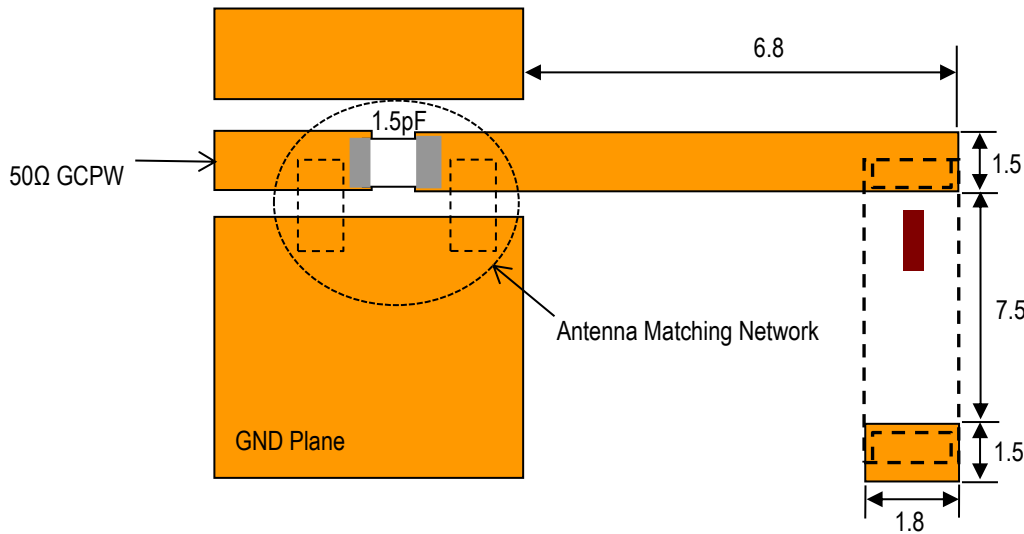

JTI P/N's for Matching Network<sup>5</sup>

Capacitor (1.5pF): QSCF500Q1R5B1GV001T

If you'd like the CAD PCB layout or have any questions,  
contact our application engineers at <https://www.johansontechnology.com/ask-a-question>

<sup>5</sup> It is recommended that the designer leave available slots for a "pi" (or shunt-series-shunt) network. The antenna matching network values above are used when antenna is mounted on Johanson's evaluation board. The matching values on client's PCB will be different, depending on the layout, thickness, material, etc. Go to: <https://www.johansontechnology.com/tuning> and see how to obtain the new values.

**Evaluation Board Typical Return Loss Measurement (P/N 2450AT45A0100001CE2)**

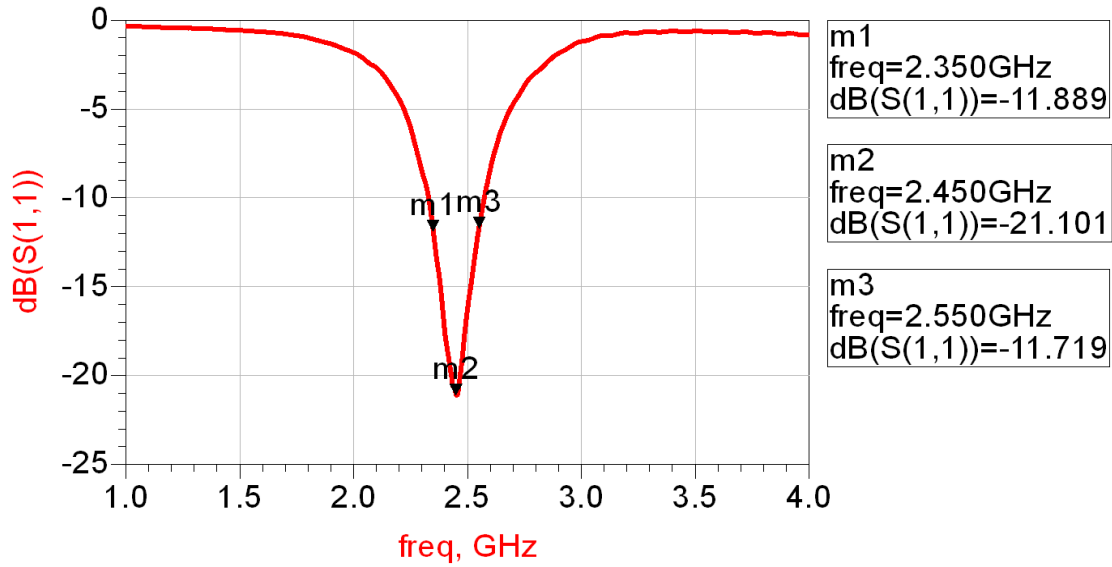

**Evaluation Board Typical 2D Radiation Patterns @2450 MHz (P/N 2450AT45A0100001CE2)**

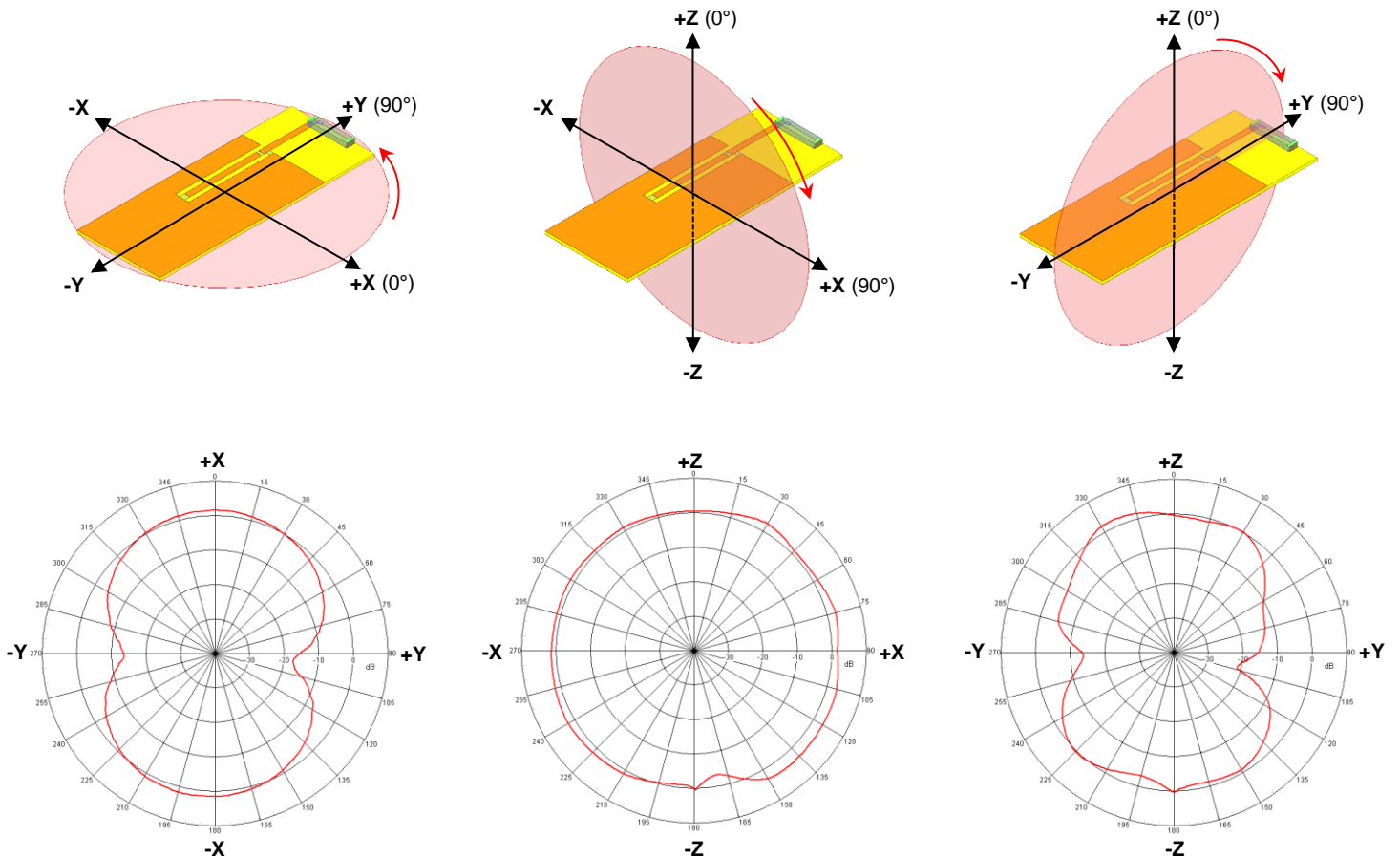

**Evaluation Board and Recommended Mounting Configuration 3 (P/N 2450AT45A0100001CE3)**

All units in mm

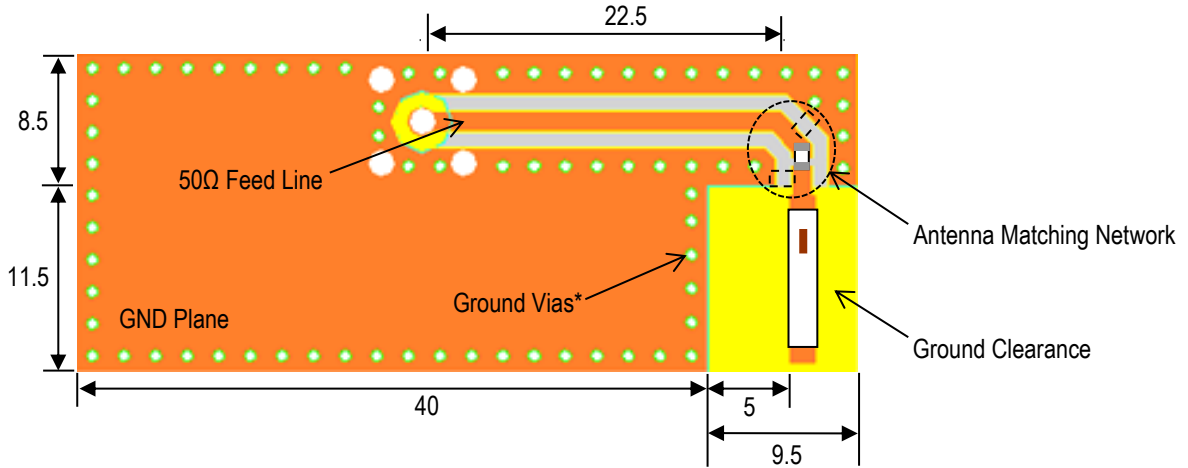

\*Note: Ground Vias are highly recommended to have better antenna efficiency.

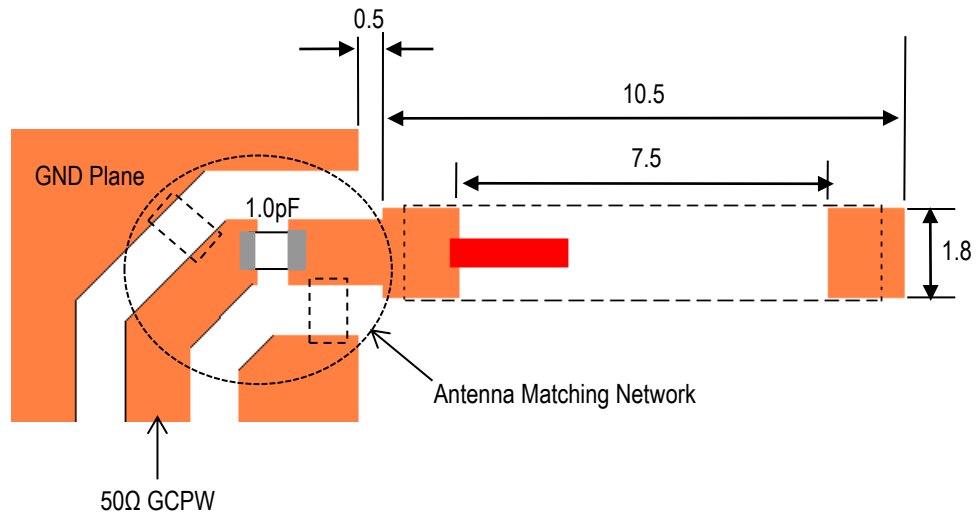

JTI P/N's for Matching Network<sup>6</sup>

Capacitor (1.0pF): QSCF500Q1R0B1GV001T

If you'd like the CAD PCB layout or have any questions,  
contact our application engineers at <https://www.johansontechnology.com/ask-a-question>

<sup>6</sup> It is recommended that the designer leave available slots for a "pi" (or shunt-series-shunt) network. The antenna matching network values above are used when antenna is mounted on Johanson's evaluation board. The matching values on client's PCB will be different, depending on the layout, thickness, material, etc. Go to: <https://www.johansontechnology.com/tuning> and see how to obtain the new values.

**Evaluation Board Typical Return Loss Measurement (P/N 2450AT45A0100001CE3)**

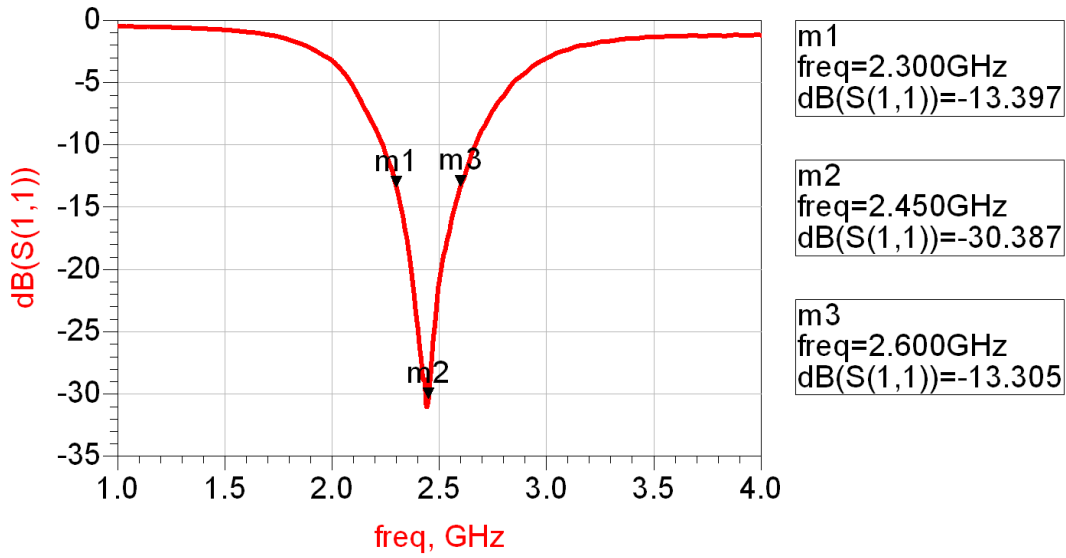

**Evaluation Board Typical 2D Radiation Patterns @2450 MHz (P/N 2450AT45A0100001CE3)**

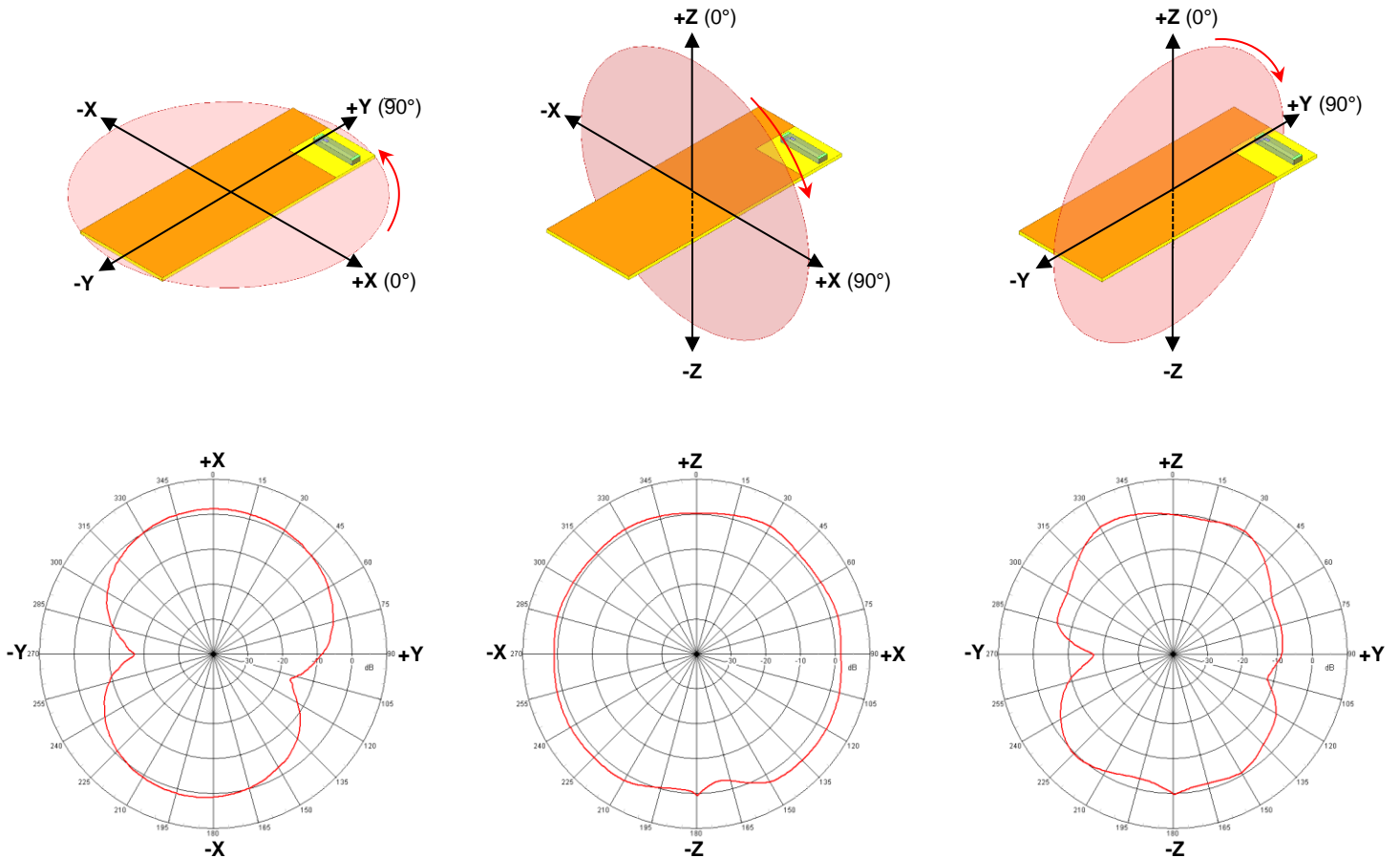



**Tape and Reel Specification (Units in mm)**

**Tape Dimensions**

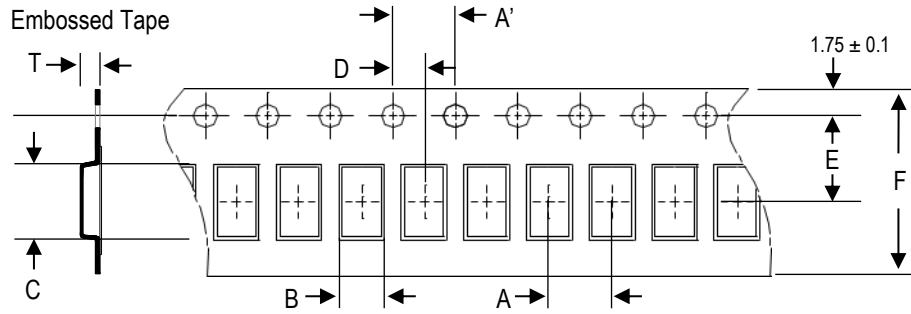

| A         | A'        | B          | C         | D          | E         | F          | T         | Quantity/reel | Tape material      |
|-----------|-----------|------------|-----------|------------|-----------|------------|-----------|---------------|--------------------|
| 4.0 ± 0.1 | 4.0 ± 0.1 | 2.35 ± 0.1 | 9.7 ± 0.1 | 2.0 ± 0.05 | 7.5 ± 0.1 | 16.0 ± 0.1 | 1.4 ± 0.1 | 1,000pcs.     | Plastic (Embossed) |

**Reel Dimensions**

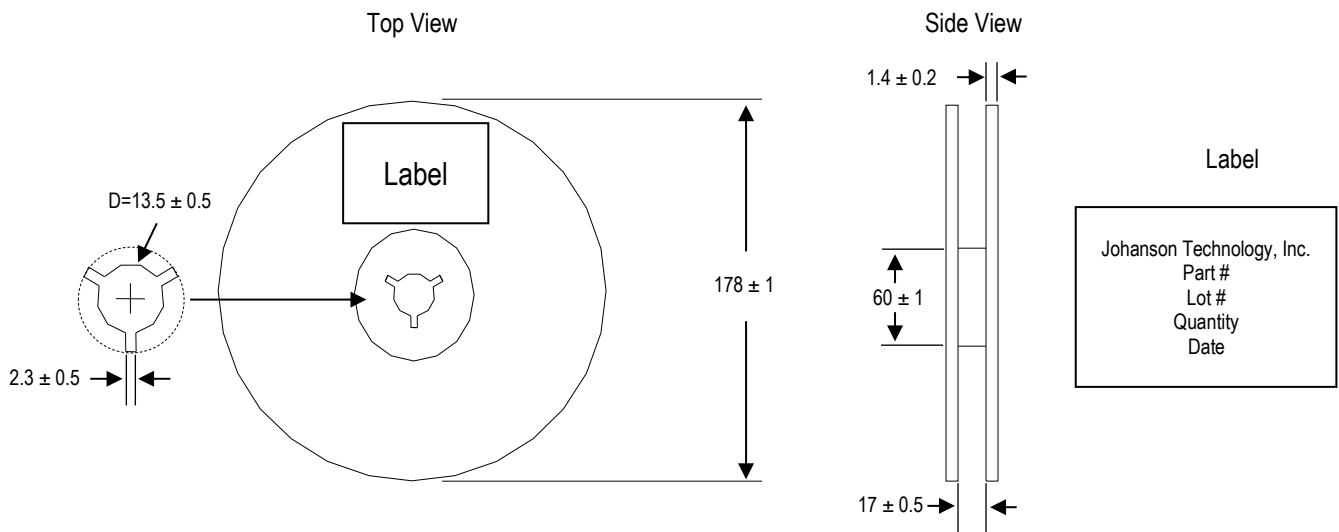

**Leader and Trailer Dimensions**

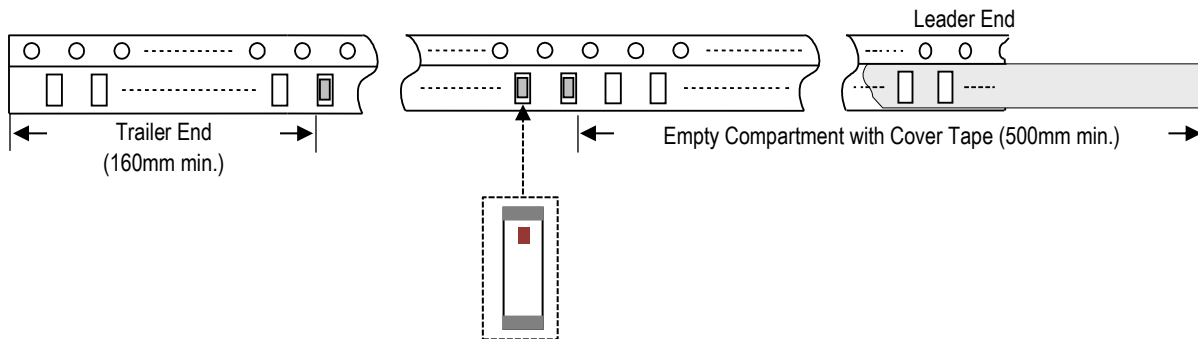

**Orderable Part Number**

| Packaging Style                       | Part Number                              | Termination |
|---------------------------------------|--|-------------|
| Bulk (loose pcs.)                     | 2450AT45A0100002B                        | Nickel Tin  |
| T & R (7" Reel Embossed Tape)         | 2450AT45A0100002E (Qty: 1,000 pcs./reel) |             |
| Evaluation Board with 1 SMA Connector | 2450AT45A0100001CE1 (Page 3)             |             |
|                                       | 2450AT45A0100001CE2 (Page 5)             |             |
|                                       | 2450AT45A0100001CE3 (Page 7)             |             |

**Important Links**

[2450AT45A0100002E Product Page](#)

[More RF Chip Antennas](#)

[Antenna Tuning, Optimization, and Validation Services](#)

[Soldering Information](#)

[MSL Information](#)

[Packaging Information](#)

[Recommended Storage Condition and Max Shelf Life](#)

[RoHS Compliance](#)

*Contact our application engineers for a PCB layout review.*

Johanson Technology, Inc. reserves the right to make design changes without notice.

All sales are subject to Johanson Technology, Inc. terms and conditions.