

2.44 GHz RF Chip Antenna

- 2.4 – 2.485 GHz Operational Frequency
- Bluetooth, WLAN
- SMD, patch, 12x12x4mm (LxWxT)
- Can be mounted in the center, corner or edge
- Linear polarization
- RoHS compliant

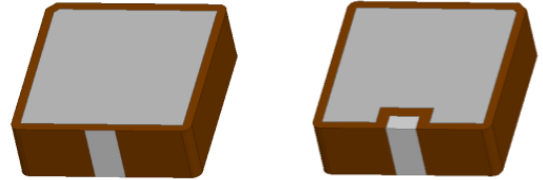

Johanson Technology, Inc. (JTI) miniature RF ceramic chip antennas are made using Low Temperature Co-fired Ceramic (LTCC) technology which has the ability to embed low and high dielectric constants inside our antenna. This enables our components to have high detuning resilience and stability over extreme temperatures (~2ppm).

Recommended mounting locations for this antenna

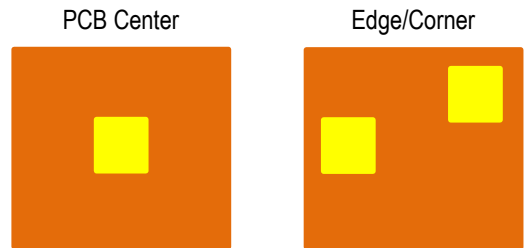

General Specifications^{1 2}

Operational Frequency (MHz)	2400 - 2485
Impedance (Ω)	50
Return Loss (dB)	6 Min.
Peak Gain (dBi)	3.5 Typ.
Average Radiated Efficiency (%)	70 Min.

Maximum Ratings

Power Capacity (W)	3 Max. (CW)
Operating Temperature ($^{\circ}\text{C}$)	-40 to +85
Recommended Storage Conditions post-installation ($^{\circ}\text{C}$)	-40 to +85
Recommended Storage Conditions and Period for Unused T&R Product ³	45% - 75% RH +5 to +35 $^{\circ}\text{C}$ 18 Months Max.

¹ Typical value represents average measurement at 25 $^{\circ}\text{C}$. Min./Max. values represent measurements over specified operating temperature.

² General specifications measured on Johanson's evaluation board P/N 2440AT62A0085001CE1.

³ 18 months max. in vacuum sealed bag and 1 week after opened. Please keep unused parts in vacuum sealed bags. For more info go to <https://www.johansontechnology.com/silverleads-profile>.

Mechanical Dimensions

	Inches			Millimeters		
L	0.472	±	0.008	12.00	±	0.20
W	0.472	±	0.008	12.00	±	0.20
T	0.157	±	0.004	4.00	±	0.10
a	0.079	±	0.008	2.00	±	0.20
b	0.079	±	0.008	2.00	±	0.20
c	0.047	±	0.008	1.20	±	0.20
d	0.118	±	0.008	3.00	±	0.20

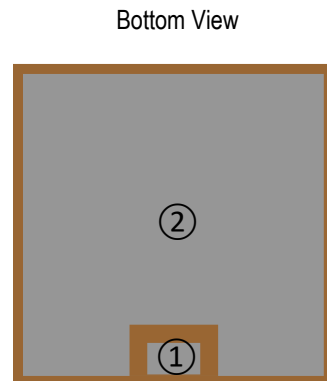
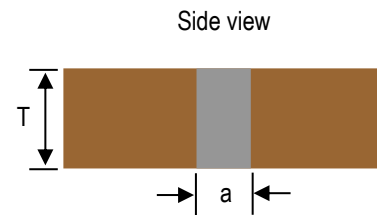
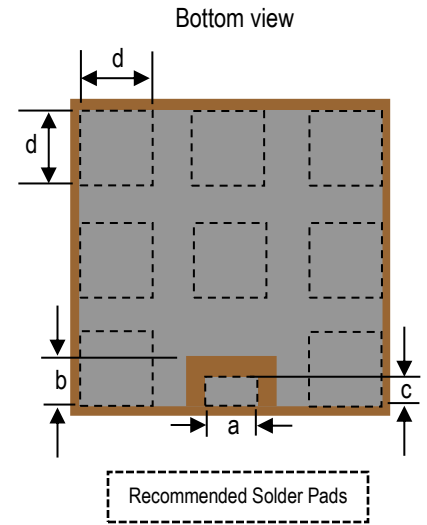
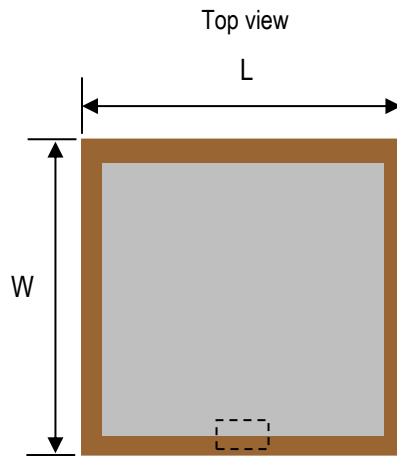

Terminal Configuration⁴

Pin Number	Function
1	Feed
2	GND

⁴ The termination type is Silver. Go to: <https://www.johansontechnology.com/ipcsoldering-profile> for Typical Soldering Profile.

Evaluation Board and Recommended Mounting Configuration 1 (P/N 2440AT62A0085001CE1)

All units in mm

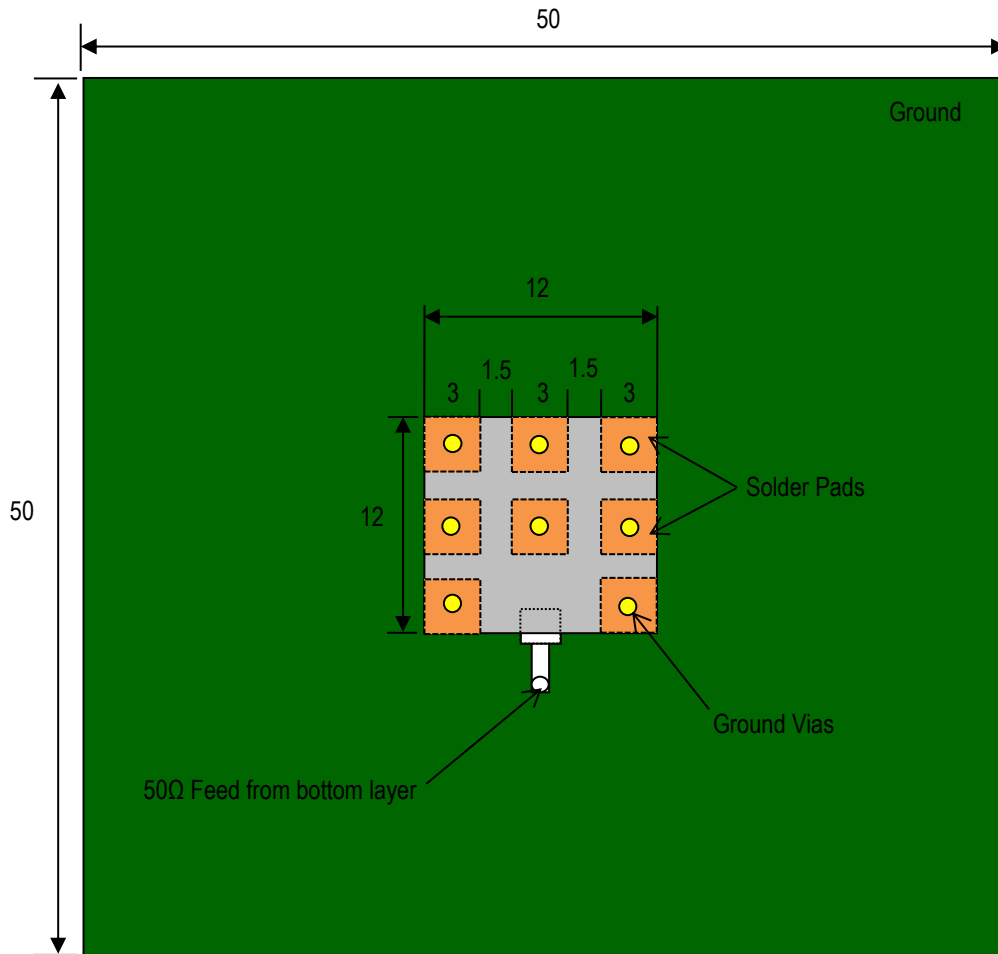

If you'd like the CAD PCB layout or have any questions,
contact our application engineers at <https://www.johansontechnology.com/ask-a-question>

Evaluation Board Typical Return Loss Measurement (P/N 2440AT62A0085001CE1)

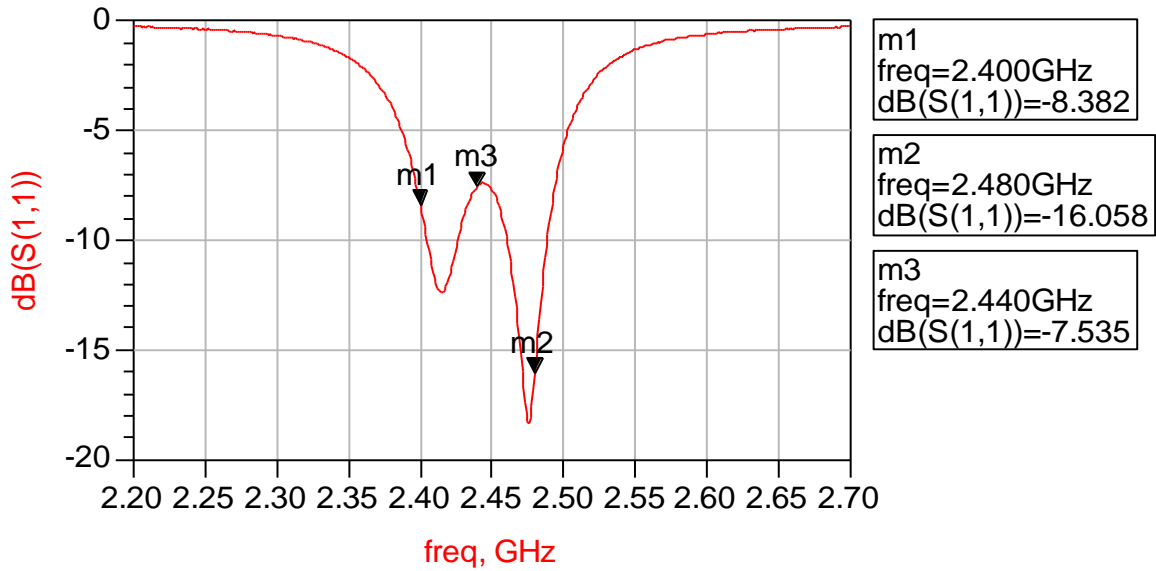

Evaluation Board Typical 2D Radiation Patterns @2440 MHz (P/N 2440AT62A0085001CE1)

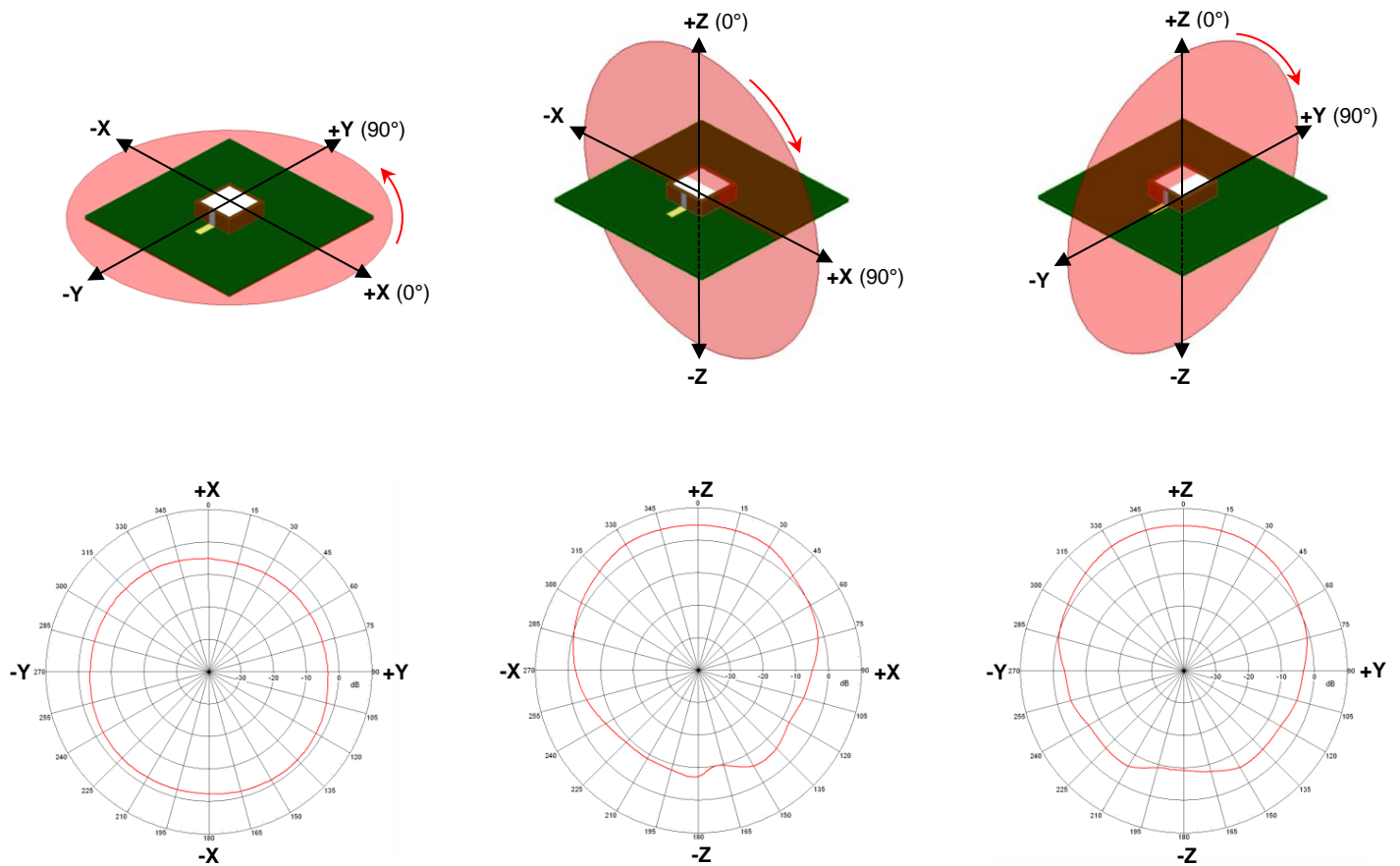

Recommended Mounting Configuration 2 (Evaluation Board Unavailable)

We have conducted internal studies to show that the following corner or edge placements provide antenna efficiency results with minimal detrimental effects.

We recommend that the antenna be mounted >3mm from any PCB edge.

All units in mm

Top Edge

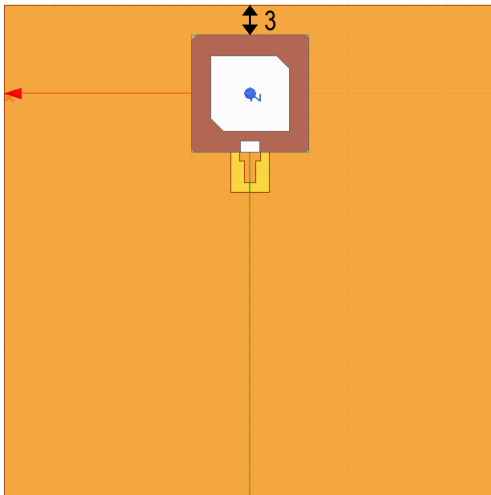

Side Edge

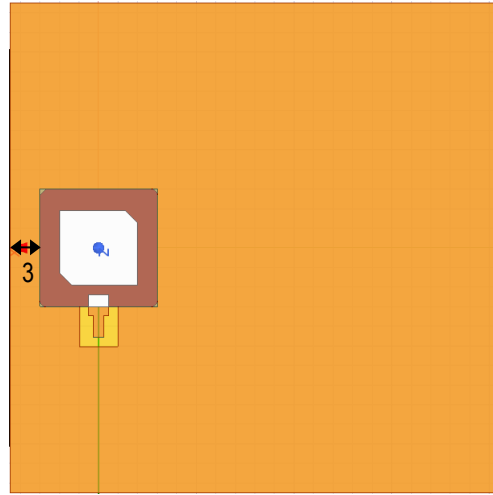

Corner

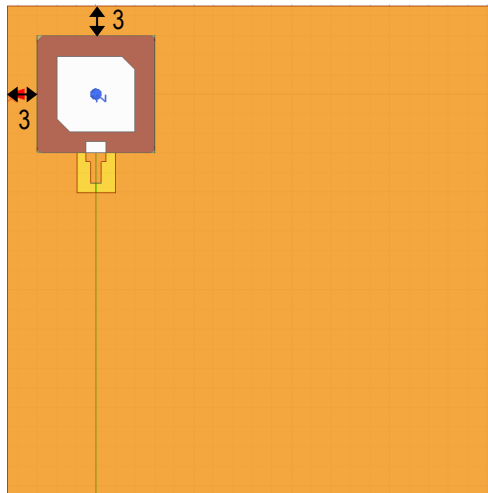

If you have any questions on this layout,
contact our application engineers at <https://www.johansontechnology.com/ask-a-question>

Tape and Reel Specification (Units in mm)

Tape Dimensions

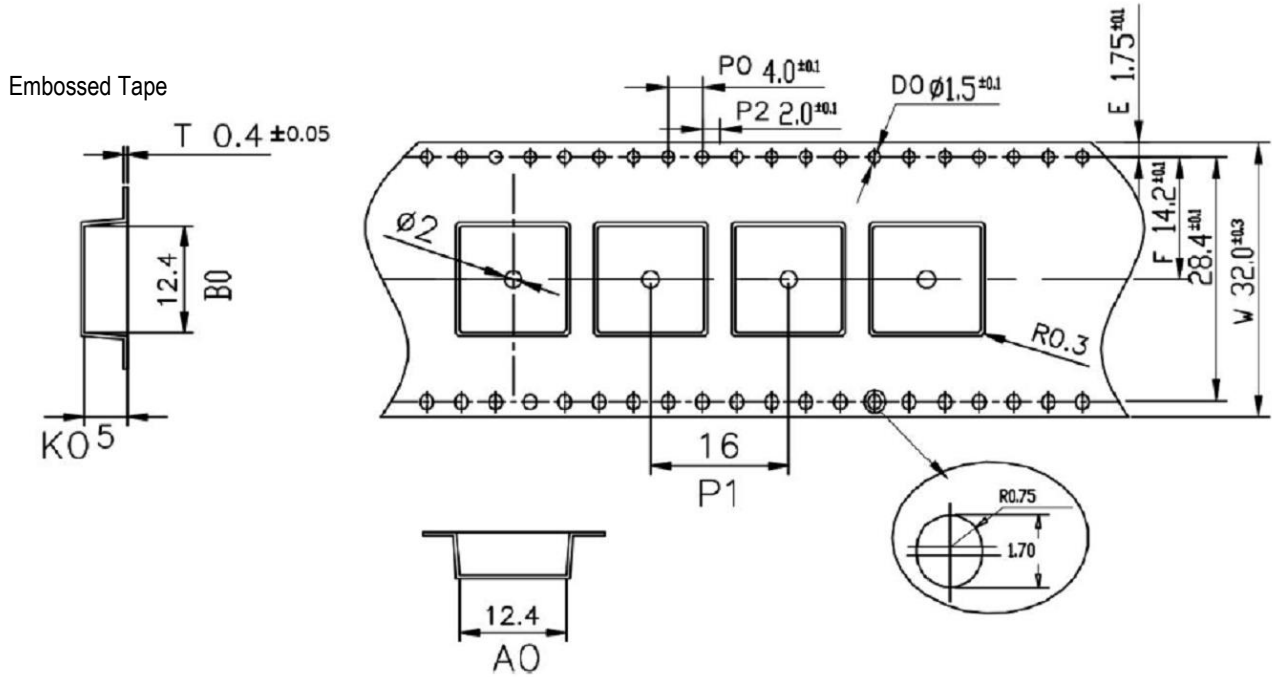

Reel Dimensions

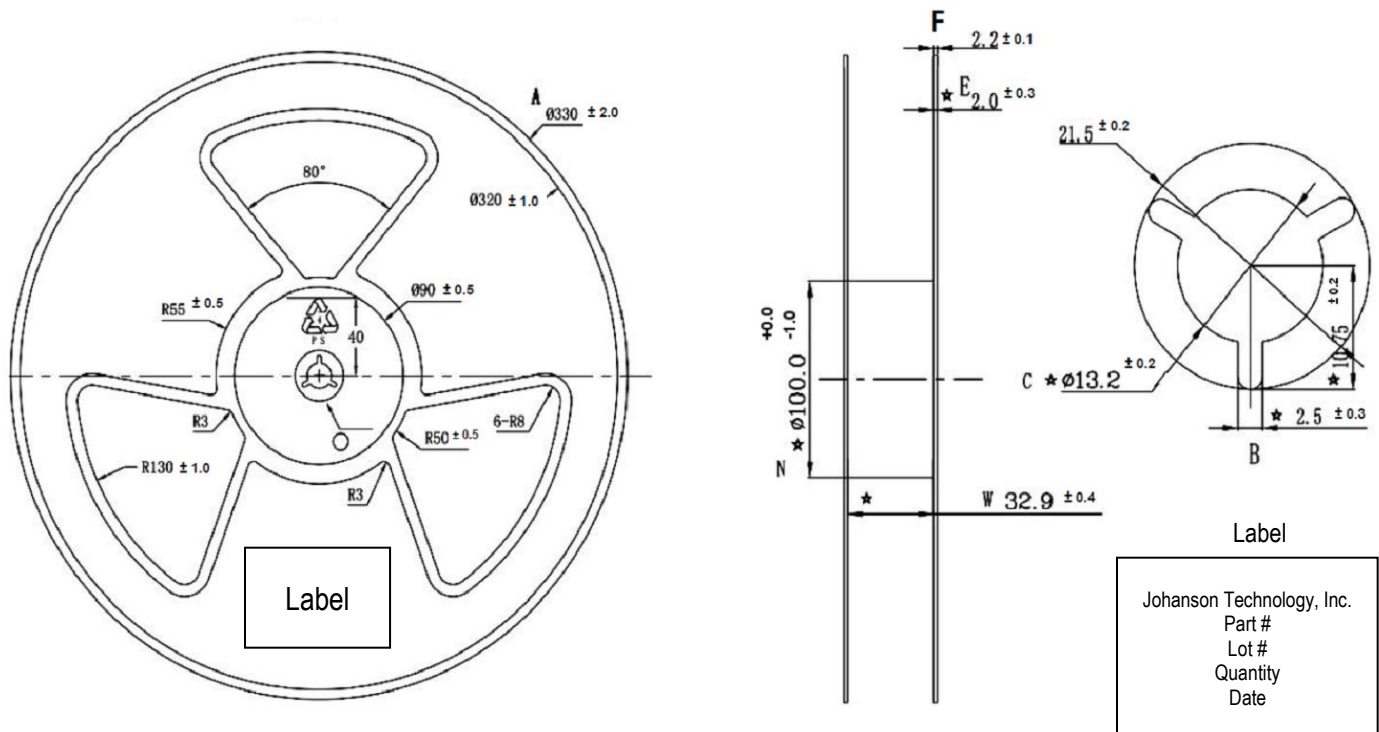



Leader and Trailer Dimensions

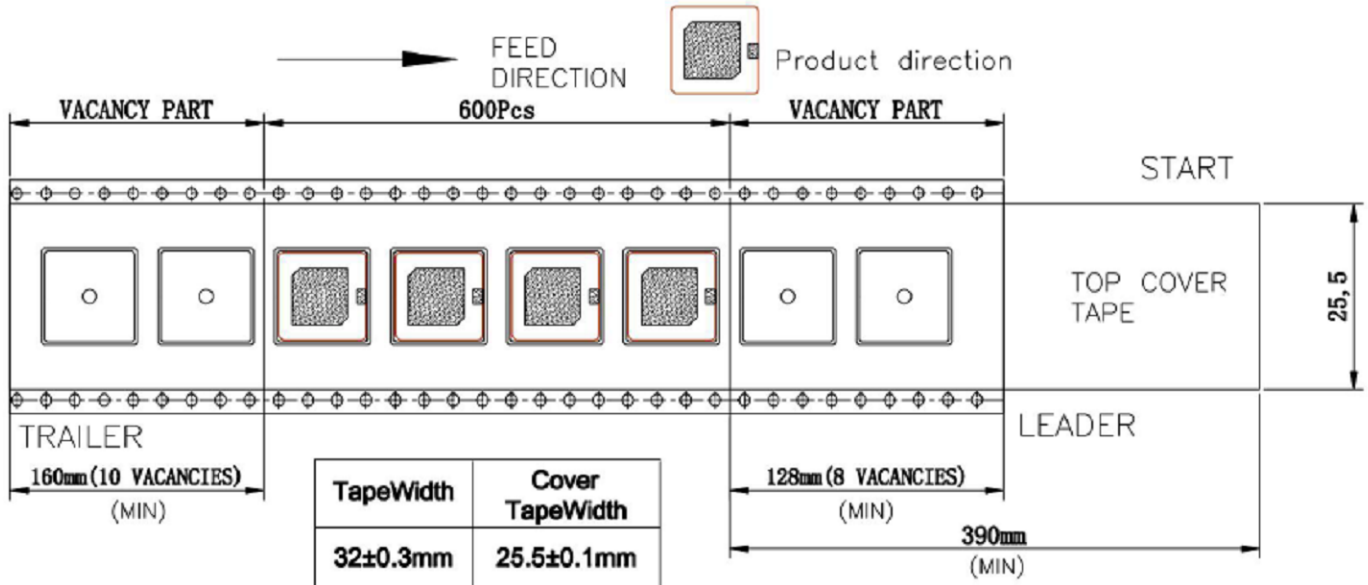

Orderable Part Number

Packaging Style	Part Number	Termination
Bulk (loose pcs.)	2440AT62A0085001B	Silver
T & R (13" Reel Embossed Tape)	2440AT62A0085001U (Qty: 600 pcs./reel)	
Evaluation Board with 1 SMA Connector	2440AT62A0085001CE1	

Important Links

[2440AT62A0085001U Product Page](#)

[More RF Chip Antennas](#)

[Antenna Tuning, Optimization, and Validation Services](#)

[Soldering Information](#)

[MSL Information](#)

[Packaging Information](#)

[Recommended Storage Condition and Max Shelf Life](#)

[RoHS Compliance](#)

Contact our application engineers for a PCB layout review.

**Johanson Technology, Inc. reserves the right to make design changes without notice.
All sales are subject to Johanson Technology, Inc. terms and conditions.**